

**SPECIFICATION SHEET**  
**Bholanath**

**STEPPER MOTOR**  
**BH86 SH 80 - 5504AK**  
**HIGH TORQUE HYBRID**

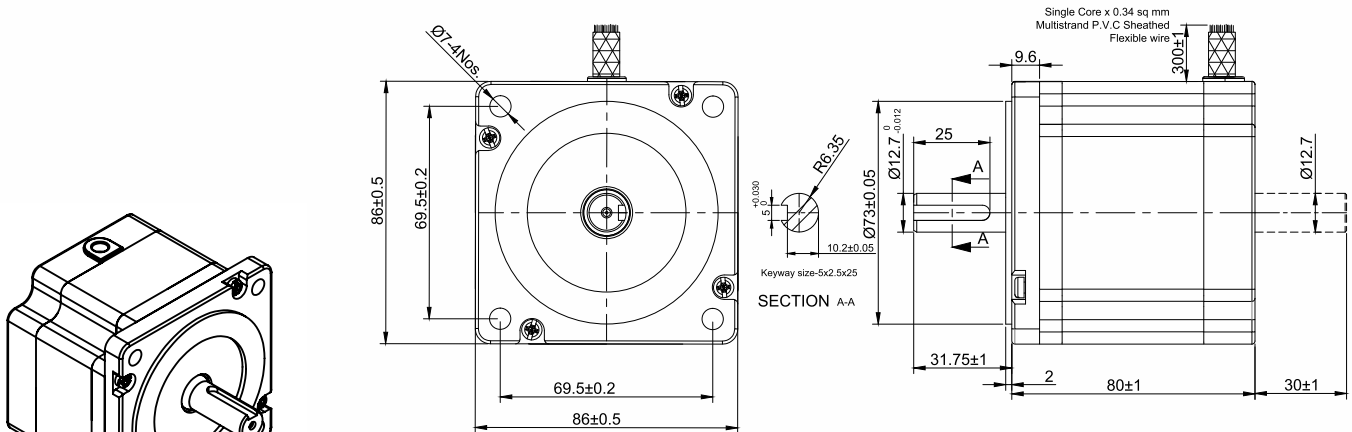

**TECHNICAL DATA**

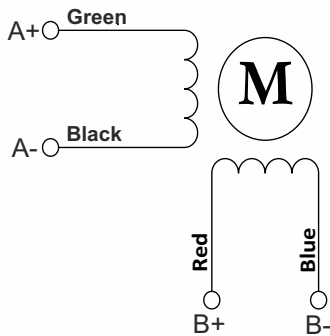

**Wiring Diagram**

SPECIFICATION		BH86SH80 - 5504 AK	
MODEL		Bipolar	
1	Rated Voltage	V	2.42
2	Current / Phase	A	5.5
3	Resistance / Phase	± 10% Ω	0.44
4	Inductance / Phase	± 20% mH	3.6
5	Holding Torque	Nm	4.6
6	Rotor Inertia	G-CM <sup>2</sup>	1400
7	Weight	KG.	2.5
8	No of Lead	N <sup>0</sup>	4
9	Operating Voltage	VDC	24 - 170
10	Operating Voltage	VAC	34 - 120

**CHARACTERISTICS**

Step Angle - 1.8°
Step Angle Accuracy - ± 3 Arc Minute
Insulation Class - H
Ambient Temperature - - 20°C + 50°C
Temperature Rise - 80°C Max. ( Rated Current Phase 2 ON )
Insulation Resistance 100 M Ohms Min.500 VDC
Dielectric Strength 820 VAC For One Minute
Shaft Radial Play 0.02 Max. Play ( 450 G Load )
Shaft Axial Play 0.08 Max. Play ( 450 G Load )
Max.Radial Force 220 N ( 20MM From Front Flange )
Max.Axial Force 60 N

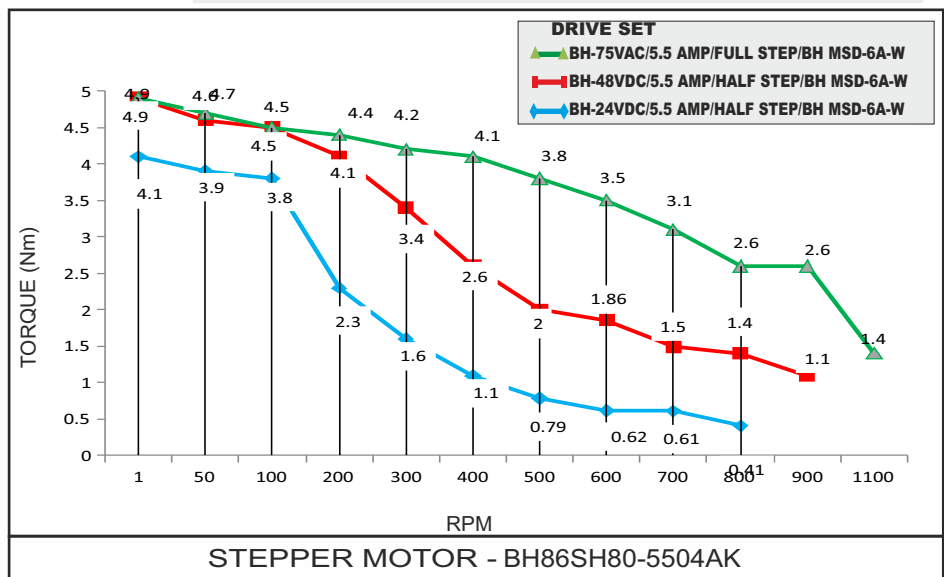

**Bholanath Precision Engineering Pvt.Ltd.**

11,Kembros Ind.Estate , Sonapur Lane , Bhandup (W),Mumbai - 400078.  
Telefax/Phone : 25662856/25664338/67993260 Email : support@bholanath.in  
Mobile No : 9920903825/9821671733/9930514603/9819515543/9323166582.