

Bholanath

Precision Engineering Pvt.Ltd.



COMMITTED TO PRECISION
www.bholanath.in

Made In India

BH-SD Series Flame Proof AC Servo Driver Manual



BH-130SM-INC-1.5KW-FLP

Flame Proof Certification



working for a safer tomorrow

Karandikar Laboratories



F 08 CE Rev. 02

- 1) **Ex EQUIPMENT TYPE EXAMINATION REPORT**
- 2) TE Report Number: **KLPL/Ex/23 -097X Issue no.00** Dated: **06-12-2023**
- 3) Ex Equipment: **Flameproof 3 Phase A.C. Servo Motor Model: BH-130SM-FLP-AC**
- 4) Manufacturer: **Bholanath Precision Engg. Pvt. Ltd.**
Plot No.1, Gut No.203, Dahagaon Wada Road, Taluka-Shahapur, Dist-Thane-421302
Maharashtra, India.
- 5) This equipment and any acceptable variation thereto are specified in the schedule to this report and the documents therein referred to
- 6) Karandikar Laboratories Pvt. Ltd. reports that this equipment has been found to comply with requirements of the following standards relating to the design and construction of equipment for explosive gas/dust atmospheres as applicable.
- 7) This TE Report was issued as verification that a sample, was assessed, tested and found to comply with the IS / IEC standards listed below.
IS/IEC 60079-0:2017 , IS/IEC 60079-1:2014
- 8) The Examination and Test results are recorded in KLPL's confidential
Report No.: KLPL/Ex/BPE-23/006 Dated: 06-12-2023
- 9) The sign X if placed after the TE report number; it indicates that the equipment is subject to specific conditions of use specified in the schedule to this TE Report.
- 10) This Report does not indicate compliance with electrical safety and performance requirements other than those expressly included in the above listed standards.
- 11) The marking of the Equipment shall include the following:
Ex Code
Ex db IIC T5 Gb (-20°C ≤ Ta ≤ +50°C)

Page 1 of 4



A. V. Karandikar
Ajit V. Karandikar
CEO

This certificate may only be reproduced in its entirety, without any change, schedule included and is subject to Karandikar Laboratories general terms & conditions

Karandikar Laboratories Pvt. Ltd.

Laboratory : Gat No. 142, Boisar Chilhar Road, Opp. Union Park, At Belegaon, Boisar (E) - 401501, Dist - Palghar Mob.: +91 88550 22824
Head Office : B-101, Ansa Indl. Estate, Saki Vihar Road, Sakinaka, Andheri (E), Mumbai-400072. Tel. : 022-28471395 / 97_022-4971 6815
Branch UAE : KL Training Academy, Office No.06, Building No. 01, Plot No.05, Mussafah 35, Abu Dhabi. Mob.: +971 56198 1452



Email : sales@karandikarlab.com Website : www.karandikarlab.com

Thank you for choosing SDD series servo driver. Please read this manual before using. The main contents of this manual include:

- * Servo driver inspection, installation and wiring steps.
- * Digital panel operation steps, status display, trouble alarm and disposal.
- * Servo system control mode, trial running and adjustment steps.
- * List of all the parameters of the servo drives.
- * Servo drives specifications.

For daily inspection, maintenance, finding the exception reasons and countermeasures, please keep this manual for easy reference.

Note: Please give this manual to the end user so as to maximize the utility of the servo drives.

- The manual contents may be changed due to the product improvements, there will be no prior notice.

- Any changes made to the product by users, the company will not undertake any responsibility and the product warranty will be invalid.

When reading this manual, please pay special attention to the following warning signs



Indicates the wrong operation may cause disastrous consequences—death or serious injury!



Indicates the wrong operation may hurt the operator and also make damage to the equipment!



Indicates improper use may damage the product and equipment!

Contents

Chapter 1 Product inspection and installation

- 1.1 Product inspection..... 3-4
- 1.2 Servo driver specification..... 5
- 1.3 Servo driver installation..... 6-7

Chapter 2 Servo driver and motor wiring

- 2.1 Servo drive power supply and periphery device wiring diagram... 8-9
- 2.2 Position control mode wiring diagram1..... 10
- 2.3 Position control mode wiring diagram2..... 11
- 2.4 Position control mode wiring diagram 3..... 12-14
- 2.5 Terminal electrical connection 15-19
- 2.6 The principle diagram of single interference 19-22

Chapter 3 Operation and display

- 3.1 Keyboard operation..... 23-24
- 3.2 Monitoring approach..... 24-25
- 3.3 Parameter setting..... 26-27
- 3.4 Parameter management..... 27-29
- 3.5 F1 operation mode..... 30
- 3.6 F2 run mode..... 30-31
- 3.7 Others..... 31

Chapter 4 Parameter

- 4.1 All parameters function and significance detail list..... 36-52
- 4.2 Parameter adjust diagram model..... 52
- 4.3 Servo key parameter description..... 53-54
- 4.4 Parameter adjust steps in actual application..... 54-55

Chapter 5 Operation and debugging

- 5.1 Special attention items when debugging..... 56
- 5.2 Position control mode 56-57
- 5.3 Speed run mode 57
- 5.4 Jog operation..... 57-58
- 5.5 Internal position/speed/torque control mode..... 58-65
- 5.6 Servo function application..... 65-66
- 5.7 Simulation speed control mode..... 66

- 5.8 Simulation torque control mode..... 66
- 5.9 Position and simulation speed hybrid control mode..... 66
- 5.10 Position and simulation torque hybrid control mode..... 66

Chapter 7 Alarm and disposal

- 7.1 Alarm list..... 78
- 7.2 Alarm process method..... 79-82
- 7.3 Common problems in use or exception handling..... 82-87

Appendix A SDD series drive and SM servo motor matching parameter list
..... 88-90

Appendix B Product after-sales service explanation..... 91

DIMENSIONS AND TECHNICAL DETAILS.

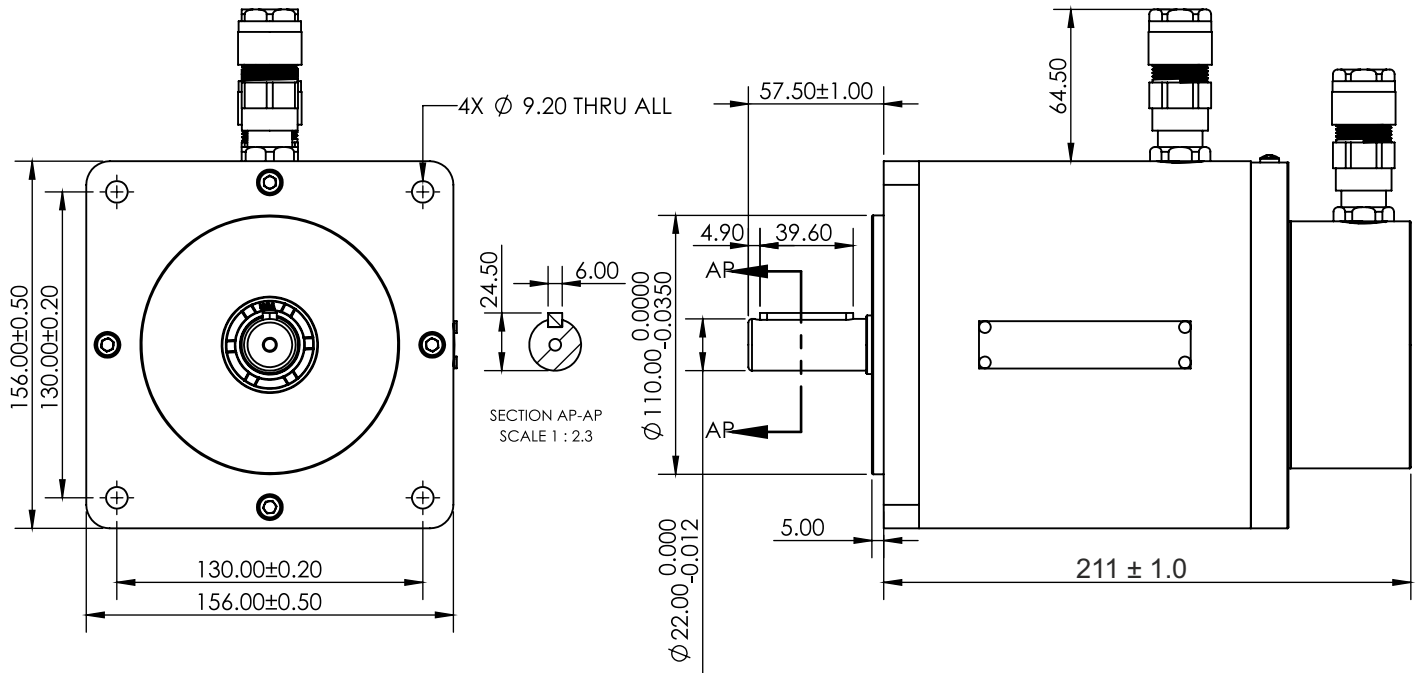

MOTOR MODEL	BH-130SM-INC-1.5KW-FLP
Rated Power (KW)	1.5
Rated Voltage (V)	230
Rated Current (A)	6
Peak Current (A)	18
Rated Speed (RPM)	2500
Rated Torque (Nm)	6
Peak Torque (N.M)	18
Back emf(v/1000r/min)	65
Torque Coefficient (Nm/A)	1.0
Rotor Inertia (Kg.MP)	1.26X10 ⁻³
Winding Resistance (Ω)	1.21
Winding Inductance (mH)	3.57
Electrical Time Constant(ms)	3.2
Weight (KG)	15.8
No of Encoder Lines (PPR)	2500
Insulation Class	Class F(130 ⁰ c)
Safety Class	IP 65
Use Environment	Temperature; -20 ⁰ c to +40 ⁰ c, humidity; relative humidity<90%

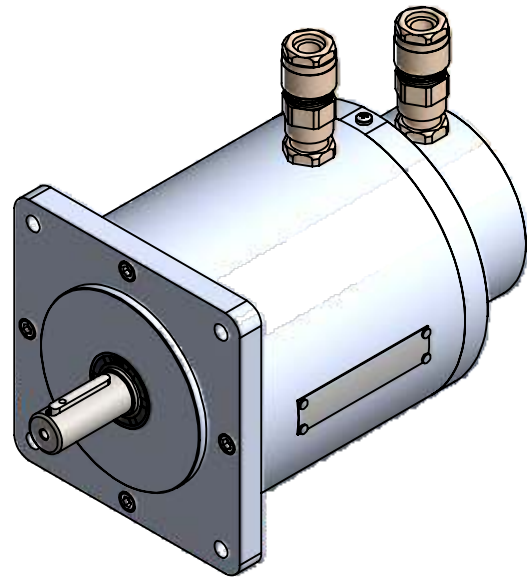

Motor Options Available -
 Standard Model - BH-130SM-INC-1.5KW-FLP
 With Low Backlash Planetary Gearbox - **PL**
 With Electro Magnetic Brake - **BRK**
 With Helical Gearbox - **HL**
 CE Certificate - N - STANDARD/CE - CERTIFIED
ORDERING CODE - BH-130SM-INC-1.5KW-FLP

Chapter 1 Product inspection and installation

Summarize

SDD series servo is our third generation servo. All the input and output port can define itself, which is convenient to the user; standard RS485 communication function, realize uploads and downloads network control; internal simple PLC function, the PLC can be completely eliminated in some easy control occasions so as to lower the cost. Compare with the second generation SDB series servo, it has obvious improvement on the function and performance.

1.1 Product inspection

Our servo products have been done a completely functional test before leaving factory, in order to prevent the product exception in the process of shipment, please check the following items carefully when open the package:

- 1) Check the servo drive and motor model whether same as ordered.
- 2) Check the servo drive and motor appearance whether with damage or scratch. If there is any above mentioned defective or abnormal signs, please contact with local distributors immediately.

Chapter 1 Product inspection and installation

1.1.2 SDD servo drive attached standard accessories

- ① CN1 plug(DB25 hole) 1 set
- ② CN2 plug(DB25 pin) 1 set
- ③ 5 pin power plug 1 piece
- ④ 3 pin power plug 1piece
- ⑤ RS485 communication line(model CABLE01) 2 piece **optional**
- ⑥ Debugging communication line(model CABLE02) 1 piece **optional**

1.1.3 Servo drive installation size

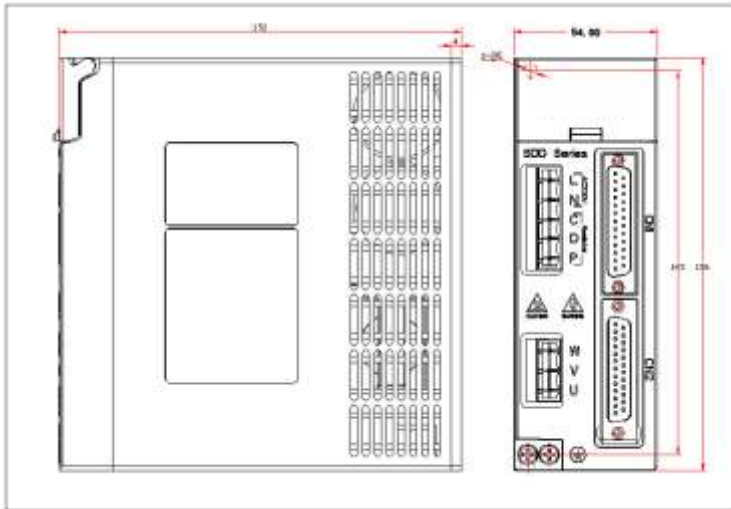

Chapter 1 Product inspection and installation

BH-SD servo drive installation dimensional

!!!!Notice: L N is 220V power supply , PD,C is external braking resistor terminals. It can not be connected wrong

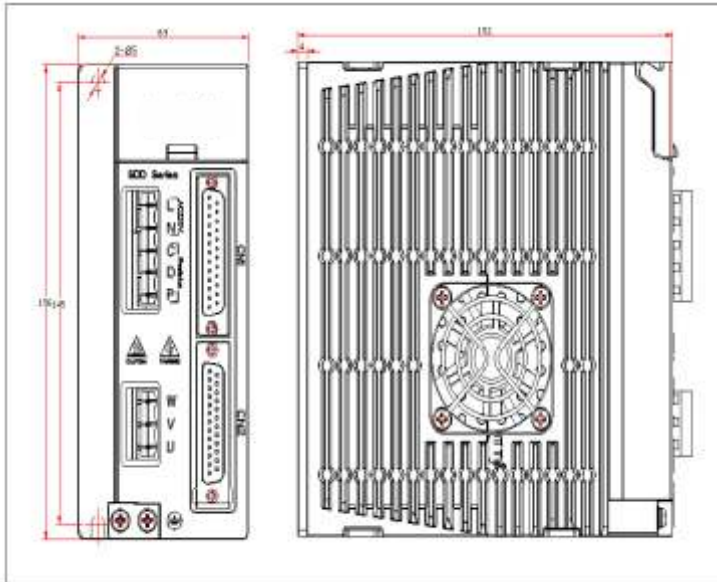

servo drive installation dimensional

!!!!Notice: L N is 220V power supply, PD,C is external braking resistor terminals. It can not be connected wrong

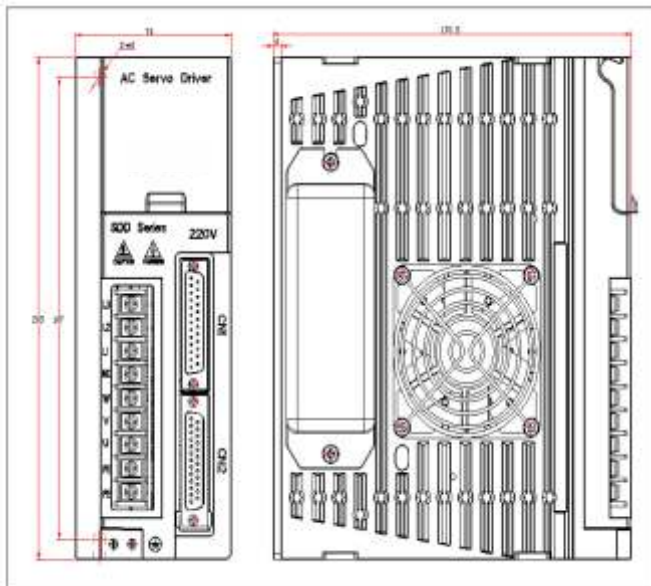

1.2 Servo drive specifications

		BH-SD-INC	
Basic specifications	mode		
	Maximum current(A)		18.0
	Power supply		single phase AC170~253V 50/60Hz
	Cooling method		Natural cooling/ fan Cooling
	Control method		SVPWM control
	Encoder		Provincial line or incremental encoder
	Internal functions	display and operation	
Control model		position control / speed trial run / jog run / internal positioning PLC function/RS485 communication/ speed/ torque	
Braking function		Internally installed	
Protection function		Under voltage, over voltage, over load, over current, encoder exception, braking, position error etc.	
Position control model	Command control model		External pulse
	External command pulse input	Form	pulse+ direction cw/ccw A/B orthogonality
		Maximum frequency	Differential motion:1MHZ open collector: 200KHZ
	Electronic gear ratio		1/32767~1/32767
	Speed control range		speed ratio: 1:5000
	Speed rate of change		Speed fluctuation ratio: $\leq \pm 0.03$ (load 0~100%) . $\leq \pm 0.05$ (power-15%~+10%)
	Command smooth way		Linear time constant 1ms 10000ms (0r/min \longleftrightarrow 1000r/min)
	frequency characteristic		300HZ
input / output signal	location signal output	output type	ABZ phase line drive output/ Z open collector output
		Frequency division ratio	1/225~1Frequency division
	input signal	7 points photoelectric isolation input	Input point can be defined as any 21kinds, see parameter settings
	output signal	4 collector open	1) location/speed reach 2) servo alarm output 3) Z signal output 4) brake output. Freely defined
Usage temperature		Operation:0°C~55°C storage:-20°C~80°C	

Chapter 1 Product inspection and installation

6

1.3 Servo drive installation

1.3.1 Installation environment conditions

Servo drive installation environment has a direct effect on the servo function and service life, therefore, the drive installation environment conditions must comply with following conditions:

Items	SDD servo drive
usage temperature/ humidity	0°C ~55°C (no frozen frost) 90%RH below (no condensation)
storage temperature/humidity	-20°C ~80°C 90%RH (no condensation)
atmospheric environment	In control cabinet, no corrosive gas, inflammable gas, oil mist or dust etc
vibration	less than 0.5G (4.9m/s ²) 10 Hz -60Hz (not run continuously)
Protection level	Ip54

When several drives installed in the control cabinet, please keep enough space for sufficient heat dissipation; please add an additional cooling fan to keep the drive ambient temperature below 55 °C .

Please install the drive by vertical way, face forward, top up for heat dissipation.

Avoid any drilling cuttings or other things falling in the drive during assembly.

Please use M4 screws when installing.

If there is vibration source (punch) nearby and can not avoid it, please use vibration absorber or add anti-vibration rubber gasket.

If there is a large magnetic switch, welding machine etc noise interference sources nearby, the drive is easily interfered by outside and make wrong action, therefore, a noise filter must be added; but the noise filter will increase leak current, so, an insulating transformer must be installed at the input end of the drive.

1.3.2 Servo installation direction and interval

Below chart shows a drive and multiple drives installation interval, the interval should be larger enough for a good heat dissipation conditions.

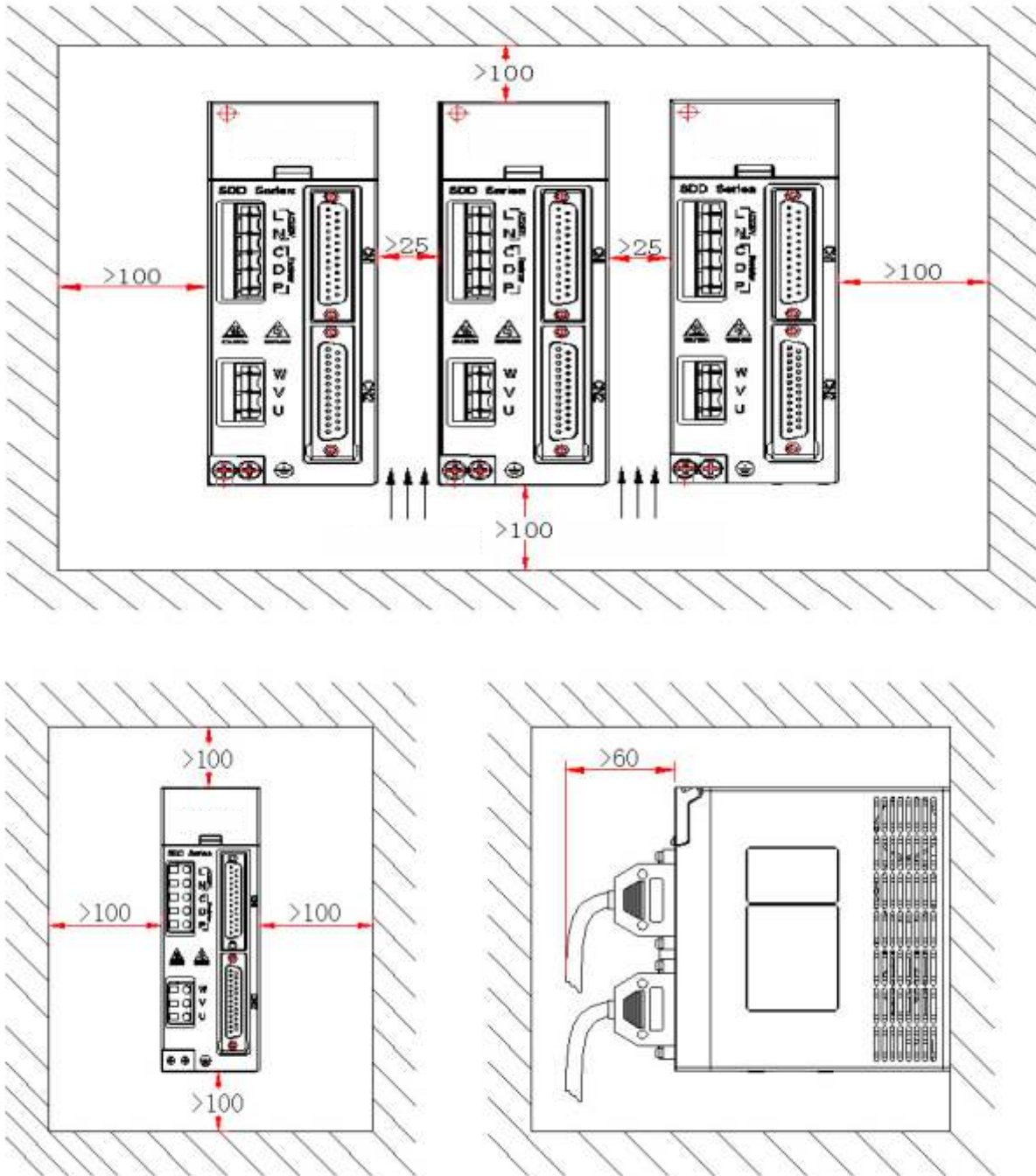

Chapter 2 Servo drive and motor wiring

2.1 Servo drive power supply and peripheral devices wiring

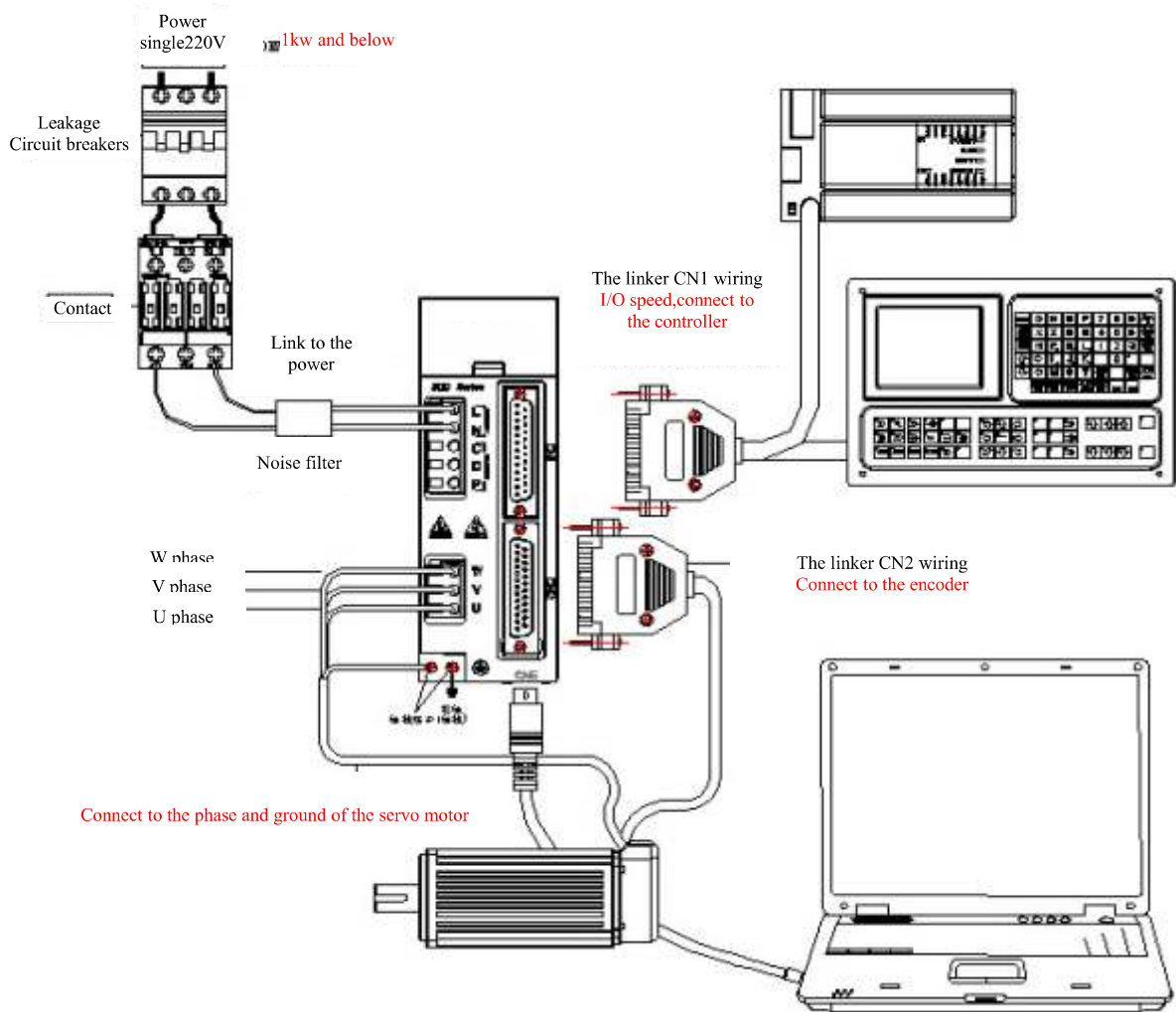

Chapter 2 Servo drive and motor wiring

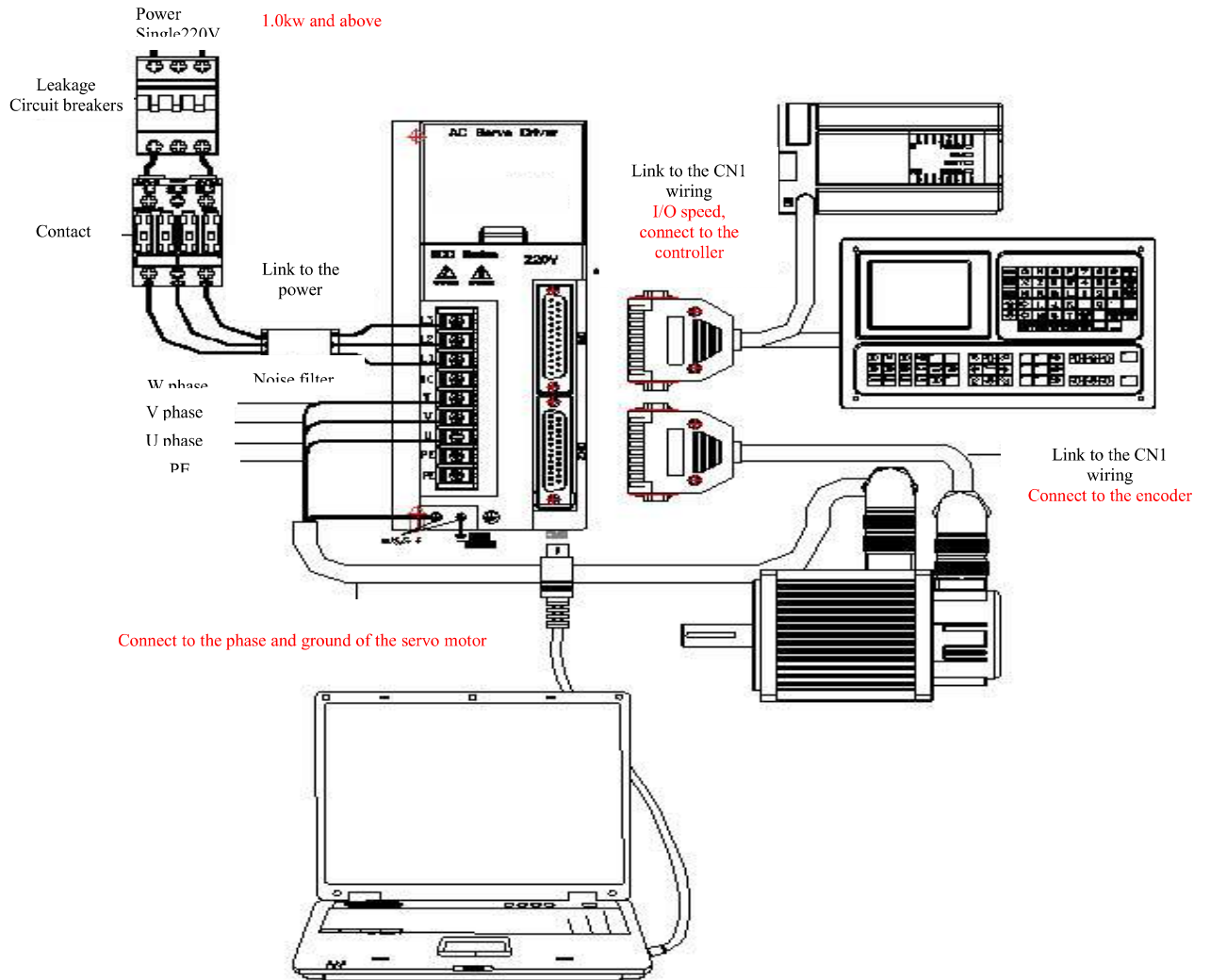

Chapter 2 Servo drive and motor wiring

2.2 Position control mode wiring diagram 1

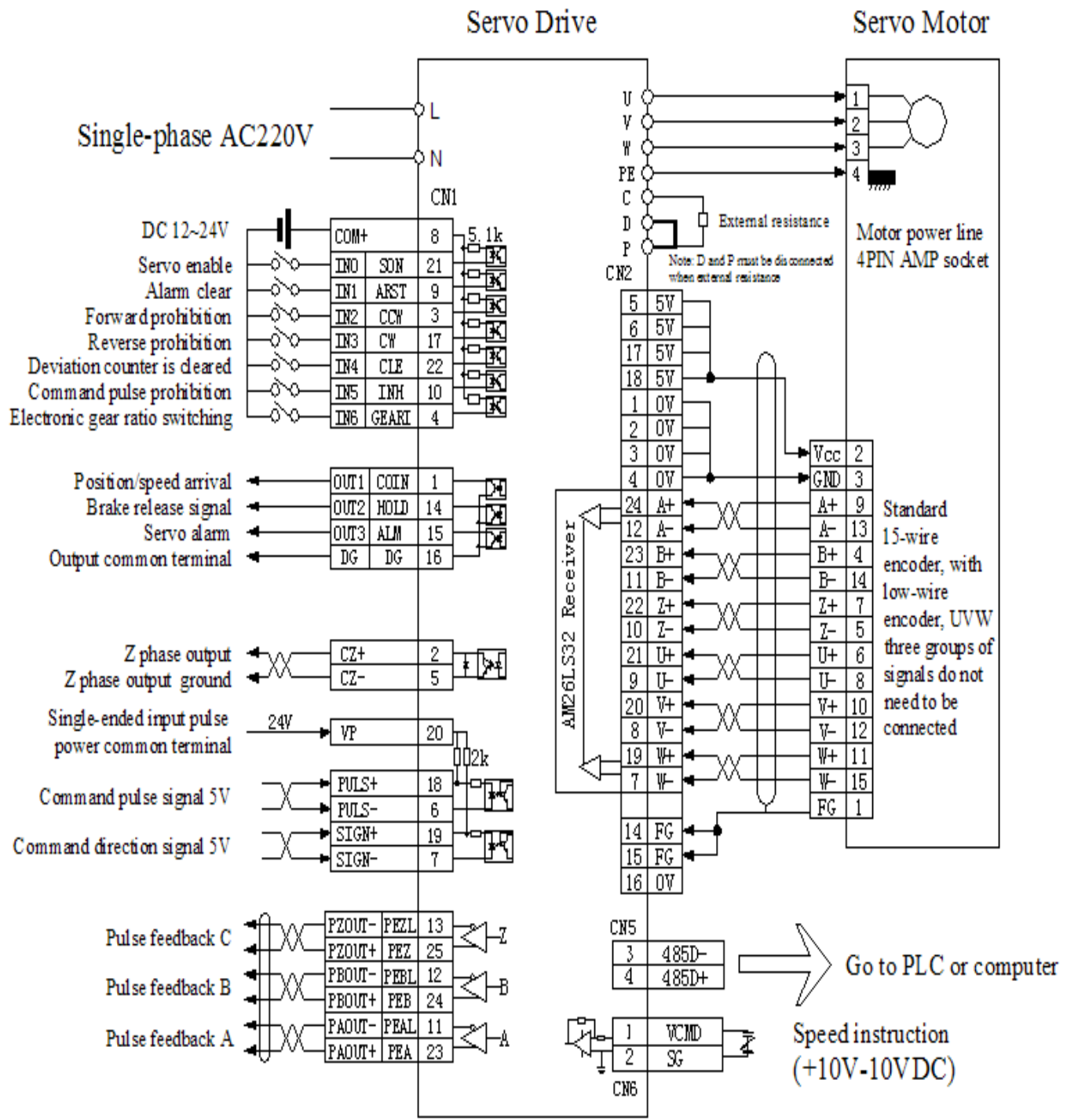

position control mode wiring diagram

2.3 position control mode wiring diagram 2

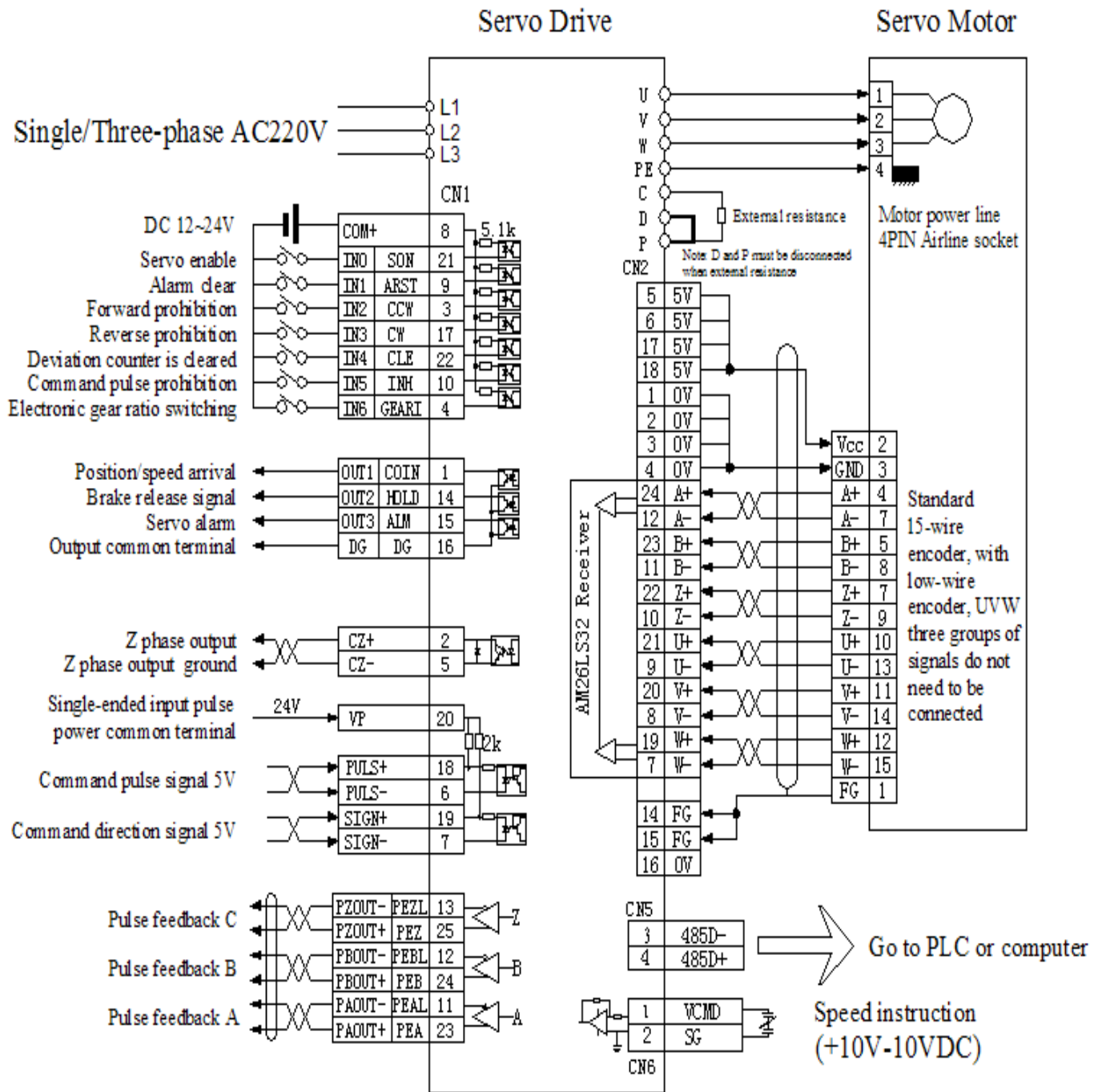

position control mode wiring diagram

Chapter 2 Servo drive and motor wiring

2.4 position control mode wiring diagram 3

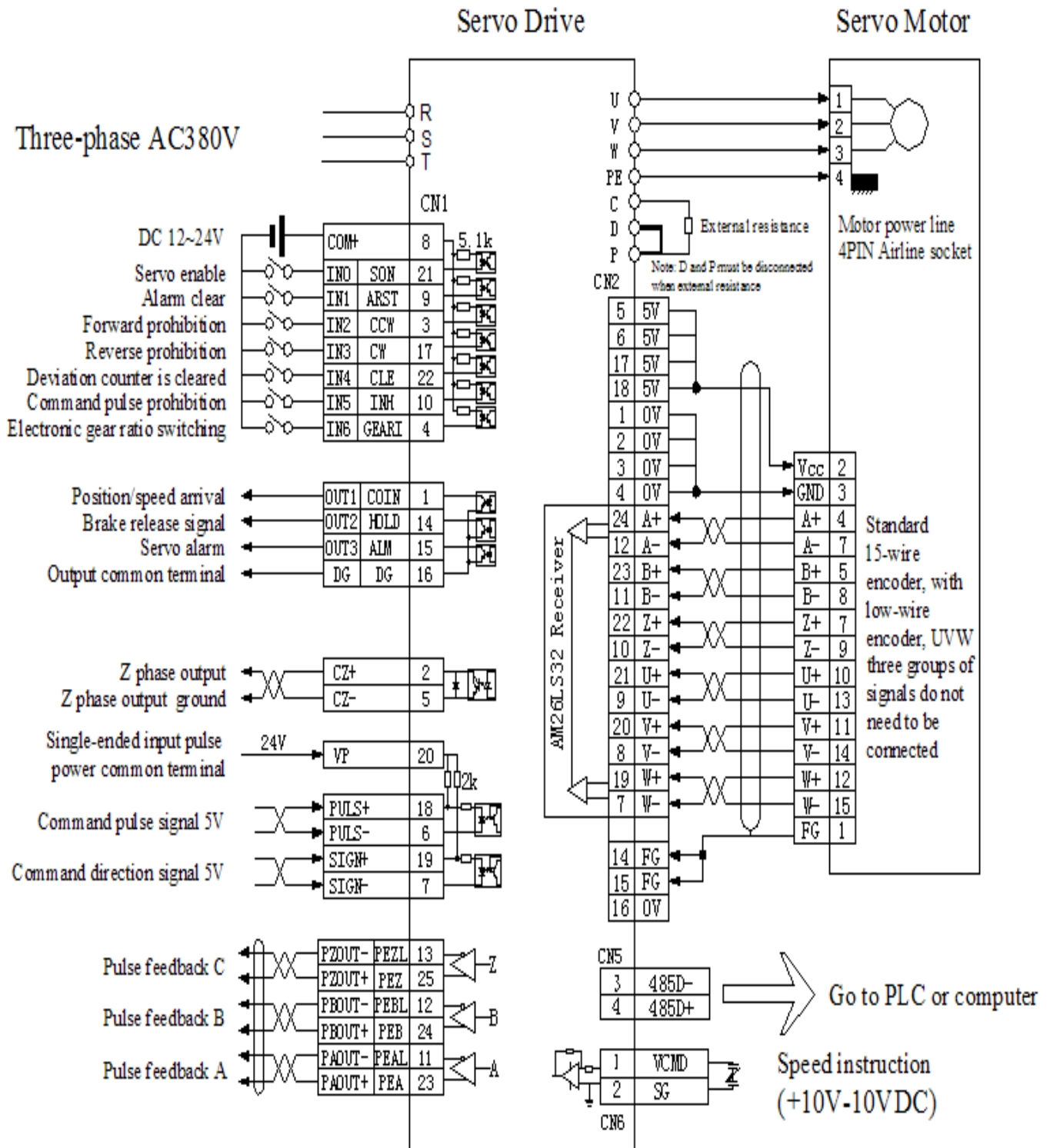

position control mode wiring diagram

internal position control mode wiring diagram(simple PLC function)

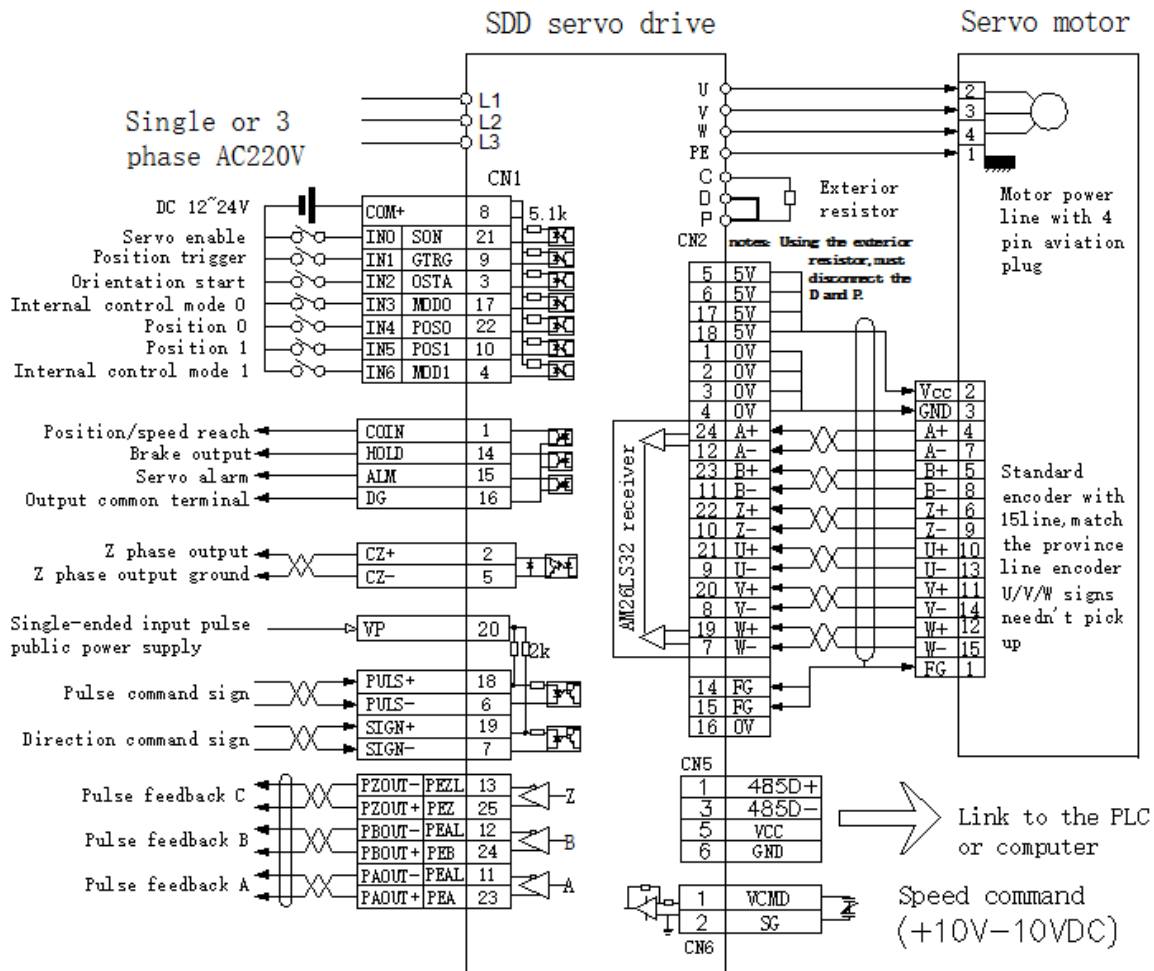

Internal position control model wiring diagram

Chapter 2 Servo drive and motor wiring

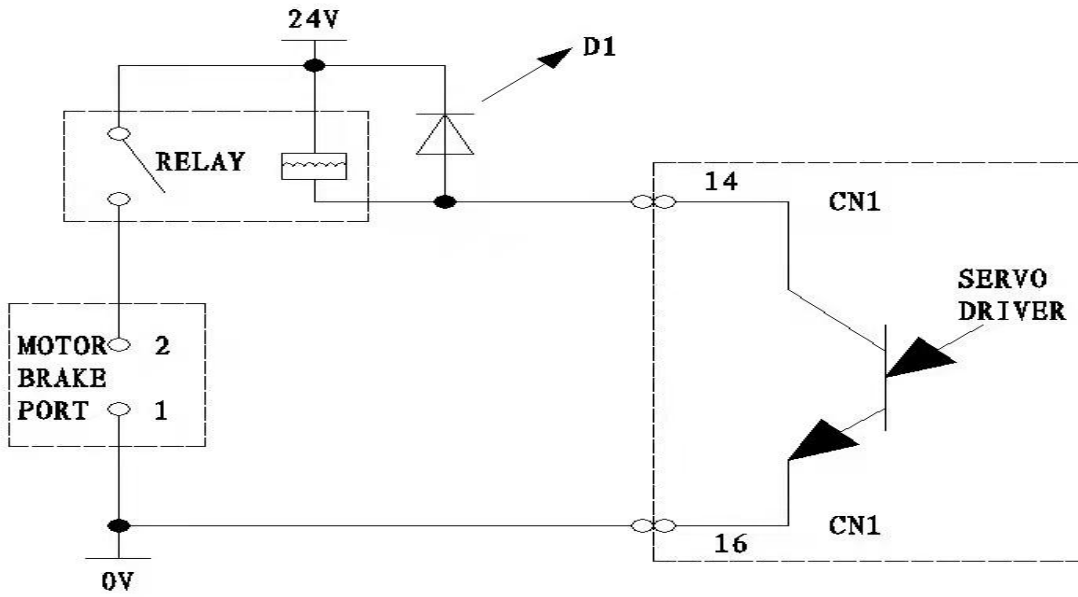

locking type brake motor wiring diagram

2.5 Terminal electrical connection

2.5.1 1、 Definition of the power terminal (SDD04NK7 series)

	Terminal marking	signal definition	function
	L	power supply	power input terminal ~220V 50Hz note: do not connect with motor output terminal U, V, W.
	N		
	P	external connect	Built-in braking resistor: P and D short circuit connection.
	D	brake resistor select terminal	With external braking resistor: P and D open. The external resistance connection between P and C.
	C		
	PE	System grounding	1、 grounding terminal resistance <math>< 100\Omega</math>; 2、 Servo motor output and power input with one public point grounding.
	W	Servo motor output	Servo motor output terminals must connect with motor terminals W,V,U
	V		
	U		

2、 Power terminal definition

	Terminal marking	signal definition	function
	L1	Power supply single-phase or three phase	power input terminal $\sim 220V$ 50Hz, single phase connect L1 L2 note: do not connect with motor output terminal U, V, W.
	L2		
	L3		
	PE	System grounding	grounding terminal resistance $< 100\Omega$; Servo motor output and power input with one public point grounding
	U	Servo motor output	Servo motor output terminals must connect with motor terminals W,V,U
	V		
	W		
	P	external connect brake resistor select terminal	Built-in braking resistor::P and D short circuit connection.
	D		With external braking resistor:P and D open.The external resistance connection between P and C.
	C		

2.5.2 Power line terminals wiring

- L1, L2, L3, PE, U, V, W terminal, transversal area $\geq 1.5\text{mm}^2$ (AWG14-16). L, N terminal, transversal area $\geq 1.0\text{mm}^2$ (AWG16-18)。
- Grounding: the grounding wire should be as thick as possible, drive and servo motor grounding at PE terminal, grounding resistance $< 100\Omega$ 。
- Suggest providing power supply by three-phase isolating transformer to reduce the possibility of electric shock hurts.
- Suggest providing power supply by the noise filter to improve the anti-interference ability.
- Please install non fuse type(NFB) circuit breakers, so that the external power supply can be cut off promptly when the drive with failure.

2.5.3 Signal terminal definition

SDD servo drive unit interface terminal configuration as follows.CN1 signal

control terminal is DB25 connector, the socket is pin type, plug is hole type; CN2 terminal feeder is DB25 connector, socket is 25 core hole type, plug is 25 core pin type.

Control terminal CN1

Terminal No	signal name	mark	I/O	System default function
CN1-8	Control Power supply positive	COM+	power supply	Power supply positive pole of input terminal Photoelectric coupler used for drive the input terminals DC12~24V, electric current \geq 100mA
CN1-21	Input port0	IN0 (SON)	input	System default: input terminals of Servo-enabled: SON ON: allow the drive to work. SON OFF: drive off, stop working, the motor in free state.
CN1-9	Input port 1	IN1 (ARST)	input	System default: servo alarm clear ON: servo alarm output normally OFF: remove the system alarm
CN1-3	Input port 2	IN2 (CCW)	input	System default: Forward drive prohibition
CN1-17	Input port 3	IN3 (CW)	input	System default: Reverse drive prohibition
CN1-22	Input port 4	IN4 (CLE)	input	System default: position deviation counter reset CLE ON: position control, position deviation counter reset
CN1-10	Input port 5	IN5 (INH)	input	System default : position command pulse prohibit input terminals INH ON: command pulse input prohibited INH OFF: Command pulse input effective
CN1-4	Input port 6	IN6 (GEAR1)	input	System default: electronic gear ratio choose terminal (default as OFF) ON: choose PN31 parameter as present position control gear ratio OFF: choose PN9 parameter as present position control gear ratio
CN1-1	Output port 1	OUT1 (COIN)	output	System default: position reach. position reach signal output , when the servo position reach to the target position (Pn12 parameter value) , output ON
CN1-14	Output port 2	OUT2 (HOLD)	output	System default: brake output Open-drain output, normal working, optocoupler breakover. Output ON No enable, drive prohibited. When alarm, optocoupler cut-off; output OFF

Chapter 2 Servo drive and motor wiring

terminal No	signal name	mark	I/O	function
CN1-15	Output port 3	OUT3 (ALM)	output	System default: servo alarm output ALM ON: servo drive without alarm, servo alarm output ON. ALM OFF: servo drive alarm, servo alarm output OFF.
CN1-16	common terminal of the output	DG	common terminal	Grounding common terminal of the control signal output terminal(except CZ)
CN1-2	encoder Z phase output	CZ+	output	the encoder Z phase output terminals: photoelectric code of the servo motor Z phase pulse output CZ ON: Z phase signal appear, optocoupler collector open circuit output
CN1-5	encoder Z phase output	CZ-	output	
CN1-18	Command pulse	PULS+	input	external Command pulse input terminals Note 1: the parameter Pn8 set pulse input model; 0. Command pulse+symbol mode; 1. CCW/CW Command pulse mode; 2. A/B orthogonal Command pulse mode
CN1-6		PULS-		
CN1-19	command direction	SIGN+	input	
CN1-7		SIGN-		
CN1-23	Output encoder signal A	PEA	output	Each round of the motor with pulse output The output pulse is mainly used to return to the upper machine. To achieve closed loop control, the frequency of the output signal can be set by PN41,PN42..
CN1-11		PEAL	output	
CN1-24	Output encoder signal B	PEB	output	
CN1-12		PEBL	output	
CN1-25	Output encoder signal Z	PEZ	output	Each motor round output a signal, the width of the signal related to the speed of the motor
CN1-13		PEZL	output	
CN1-20	External public power supply	VP	input	If the pulse signal is 24 v, connect the power supply can be without resistance
CN1-PE	Shield ground	PE		

Chapter 2 Servo drive and motor wiring

2) The feedback signal terminal CN2

terminal No	signal name	terminal mark	I/O	function
CN2-24	encoder signal A+	A+		Encoder ABZ signal
CN2-12	encoder signal A-	A-		
CN2-23	encoder signal B+	B+		
CN2-11	encoder signal B-	B-		
CN2-22	encoder signal Z+	Z+		
CN2-10	encoder signal Z-	Z-		
CN2-21	encoder signal U+	U+		Match province line type motor, UVW encoder signal does not need to connect. And PN74=1
CN2-09	encoder signal U-	U-		
CN2-20	encoder signal V+	V+		
CN2-08	encoder signal V-	V-		
CN2-19	encoder signal W+	W+		
CN2-07	encoder signal W-	W-		
CN2-1.2 .3.4	digital ground	GND		Digital
CN2-5.6 .17.18	+5V power	VCC		Power
CN2-14	shielding ground	FG		

3) Serial communication terminal

CN5

terminal No.	signal name	mark	Model	function
3	RS485 communication signal	485D-	SDD** NK**	RS485 communication signal
1	RS485 communication signal	485D+		RS485 communication signal

4) Serial communication terminal

CN5

terminal No.	signal name	mark	Model	function
3	RS485 communication signal	485D-	SDD** NK**D	RS485 communication signal
4	RS485 communication signal	485D+		RS485 communication signal

Terminal interface as shown below



2.5.4 signal terminals wiring

- Cable selection: use shield cable (It is better to choose twisted shielded cable), wire core cross-sectional area $\geq 0.12\text{mm}^2$ (AWG24-26), shield must connect with FG terminals.
- cable length: cable length as short as possible, CN1 control cable should be less than 3meters, signal feedback CN2 cable should be less than 20meters.
- Wiring: away from power cabling to prevent interference entering. Please install surge absorber component in the relevant circuit inductor components (coil); direct current coil anti-parallel free-wheeling diode, AC coil in parallel and RC absorb return circuit.

2.6 The principle diagram of the signal interface

2.6.1 digital input interface circuit

Digital input interface circuit could be controlled by relay or open collector transistor circuit. User provide power, DC12 ~ 24V, current $\geq 100\text{mA}$; note: if the current polarity reversed, the drive does not work. Input signal IN0-IN6 all can refer to this connection mode.

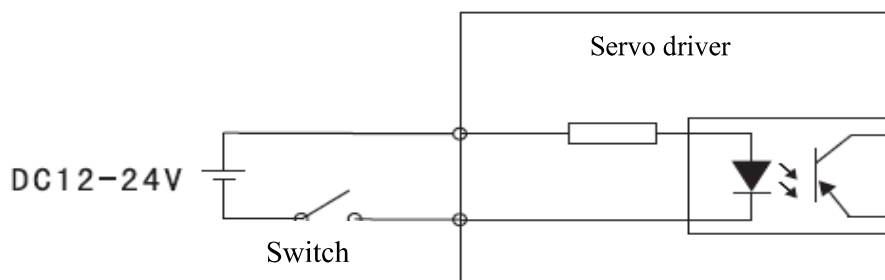

Chapter 2 Servo drive and motor wiring

When input signal connect with OV, signal is ON input and effective. It can be judged by display menu UN-17, when input ON, the corresponding nixie tube will be light. Input OFF, the corresponding nixie tube will die out. Use this display content properly, convenient for servo input signal debugging and maintenance.

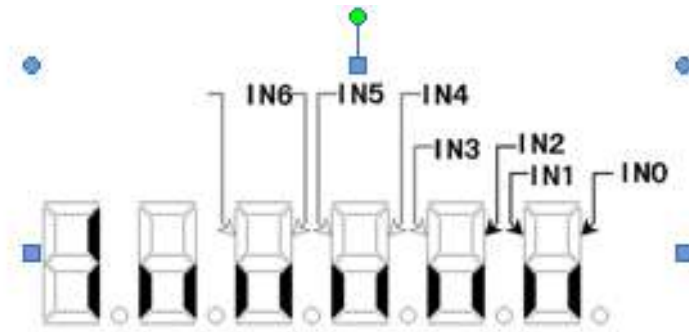

Input terminal display

(The stroke is lit to indicate ON, and to be off to indicate OFF)

2.6.2 Servo motor photoelectric encoder input interface

In the differential output mode, use AM26LS32、MC3487 or similar line drive RS422 as a receiver.

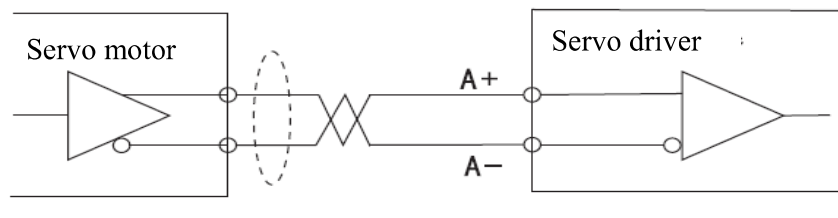

2.6.3 The pulse signal input interface circuit

In order to transmit pulse data correctly, suggest to use differential drive way; in differential drive mode, use AM26LS31、MC3487 or similar line driver RS422 as follow diagram

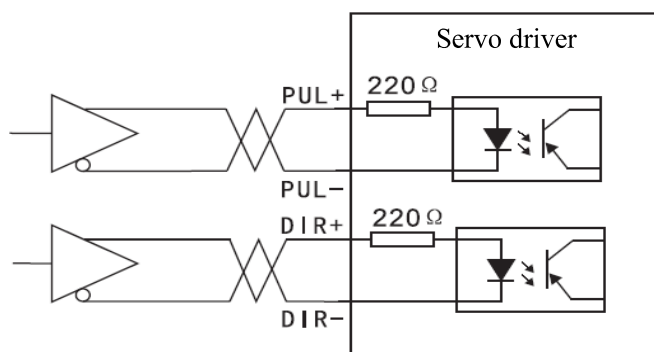

Using single-ended drive mode will lower the operating frequency.

Chapter 2 Servo drive and motor wiring

A: Input circuit according to the pulse quantity. drive current 10~25mA Limit external power maximum voltage as 24V, determine the value of resistance R. experience data:VCC=24V, R=1.3~2k; VCC=12V, R=510~820Ω。External power supply provided by user, please note that if the power polarity reversed, the servo drive unit will be damaged. Details as follow diagram.

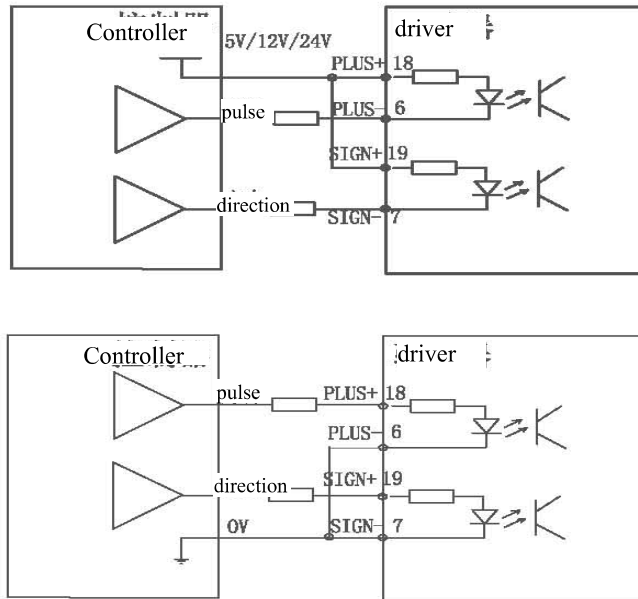

B: Don't concatenated resistance, with the internal resistance of the drive function implementation. The wiring method as diagram below.

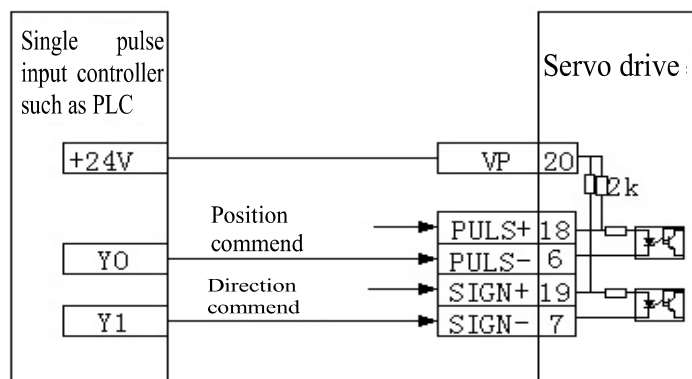

Chapter 2 Servo drive and motor wiring

2.6.4 driver speed output interface

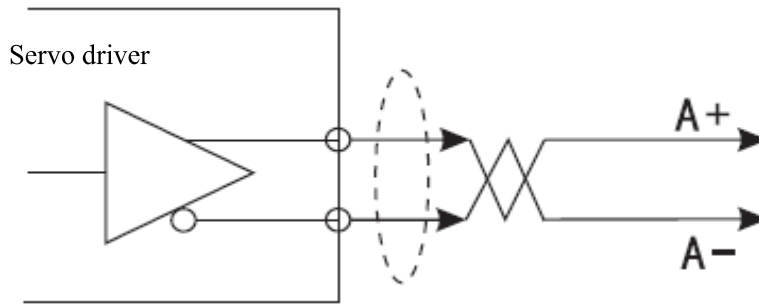

2.6.5 The digital output interface circuit

Please pay attention to the power polarity when using external power, reversed polarity will damage the drive. Digital output is open collector mode, limit external voltage maximum as 24V, maximum current is 10mA. In terms of load, when using relay etc inductive load, a diode need be added to parallel with inductive load, if the polarity of the diode is reversed, the drive will be damaged. The status of the output signal can be observed by IIN-18

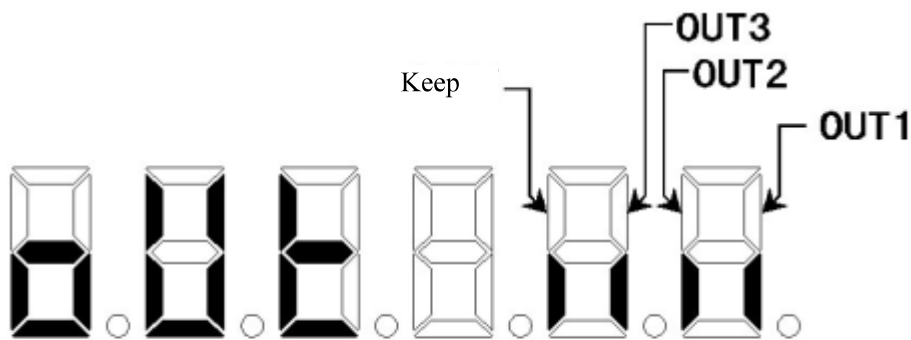
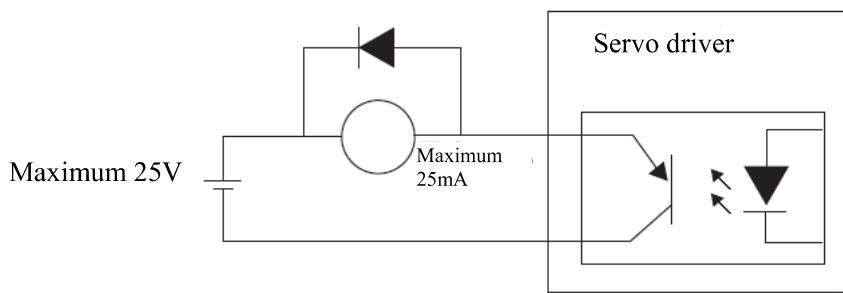

Output terminal display

Light display ON, go out display OFF

Chapter 3 operation and display

3.1 Keyboard operation







- Servo panel with 6 LED nixie tube display and 4 buttons to display various status, parameter setting . Key functions as follows:

- ▲: number, value increase, or forward.
- ▼: number, value decrease, or back.
- ◀: return to upper menu or cancel the operation.
- ↵: enter the next layer operation menu or input confirmation.

Note: ▲、▼ keep press down, repeat operation, the longer the holding time, the faster the repetition rate.

*** 6 section LED digital tube display all kinds of status and data of the system, all digital tube or the decimal point of the rightmost digital tube blink, it means alarm.



*** According to multiple-layer menu to operate, the first layer is main menu, including 8 kinds operation mode, the second layer is the function menu of all operation modes. The below diagram shows the main menu operation:

















Display status	meaning
	Status surveillance
	parameter
	Parameter operation
	Internal speed run
	Jog operation
	Encoder adjustment

Chapter 3 operation and display

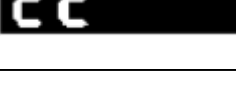























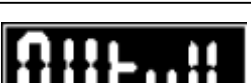

	Open loop run
---	---------------

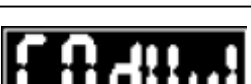
3.2 Monitoring method

Choose “Un-” in the first layer, press  entering monitoring mode; there are 22 display status, the user use ,  to choose the display mode.

















Display status	Display code	Display meaning	Example
		Motor speed	Current motor speed is 500 turn
		present position low 5	
		present position high 5	
		Command pulse low 5	
		Command pulse high5	
		Position deviation low 5	
		Position deviation high 5	
		Motor torque	
		Motor current	

Chapter 3 operation and display

		present linear speed	
		Control mode	
		pulse frequency	
		Speed command	
		Torque command	
		Rotor absolute position	
		Empty	
		Input signal status	
		Output signal status	
		Encoder signal status	
		Running status	
		Alarm code	
		Reserve	
		Display analog AD value	

Chapter 3 operation and display

3.3 Parameter setting

Choose “PN-” in the first layer, and press key  to enter parameter setting mode. Use 、 to choose parameter, press key , display the value of the parameter, use 、 to modify parameter values. press  or  once, parameter increase or decrease one, press and keep  or , the parameter can be increase or decrease continuously. When the parameter value is modified, the rightmost LED digital tube lit up, press  to make sure the modified value effective, the LED digital tube decimal point of the right side go out, the modified value will be reflected in the control immediately, then press  or  keep on modify parameter, after modified press  back to the parameter selection status. If you are not satisfied with the value you are modifying, do not press , can press  to cancel, restore original parameter value, and back to the parameter selection status.

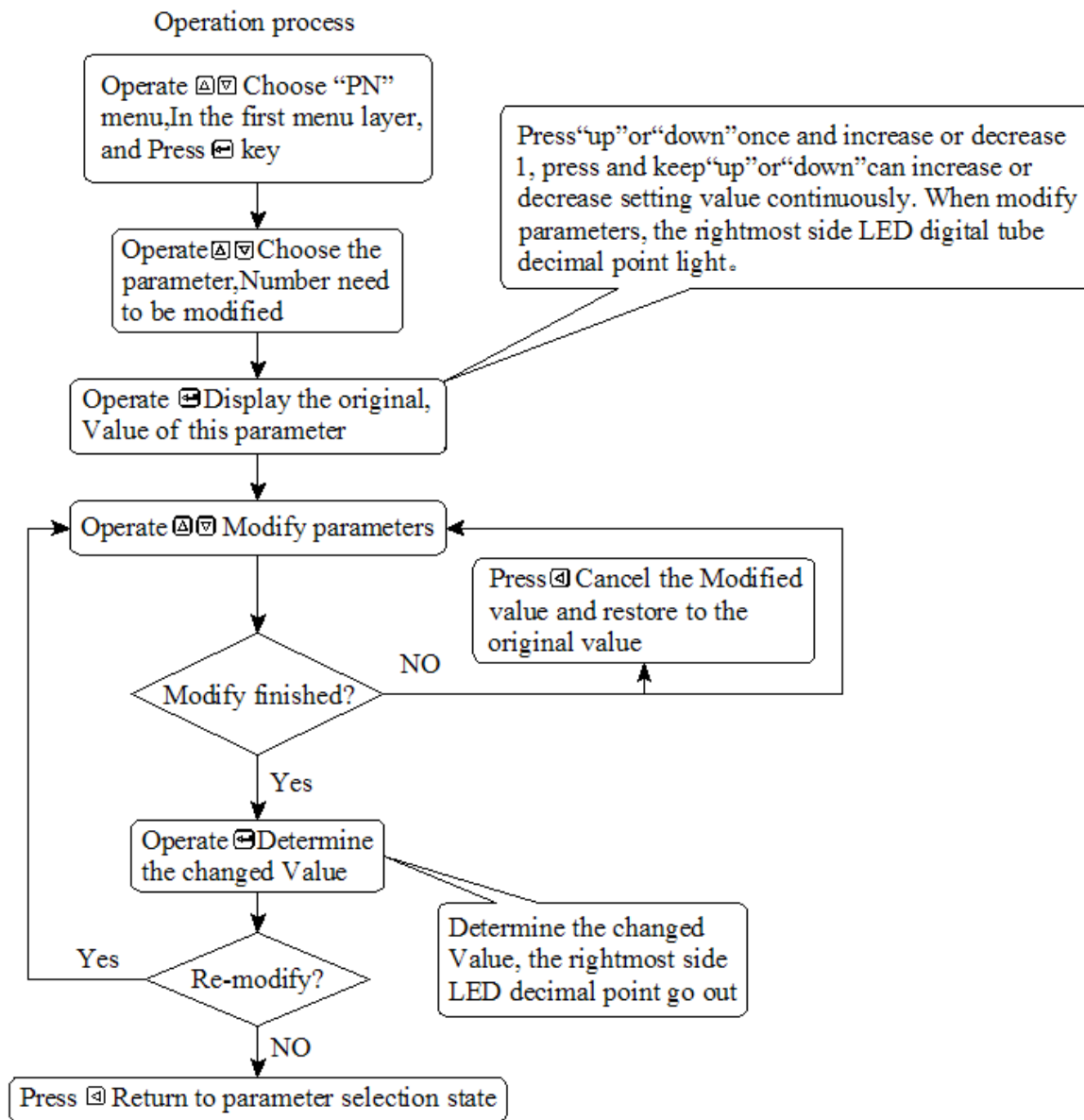

3.4 Parameter management

Parameter management mainly deals with the operation between memory and EEPROM, choose "Sn-" in the first layer, and press entering parameter management mode. First, choose the operation mode, there are 5 modes, use 、 to choose. Take "parameter write in" for example, choose "Sn-Set", press

Chapter 3 operation and display

← and keep more than 2 seconds, if the write success, display “DONE”, if fail, display “ERR”. Press ← again back to the operation mode selection status.

Sn – SEt parameter write in, it means to write the memory parameter to the parameter area of EEPROM. When the users changed the parameters, only the memory parameter values changed, next power supply will be restored to the original value. If you want to change the parameter values permanently, need to perform write in operation, write the memory parameter into parameter area of EEPROM, next power supply will use the modified parameters.

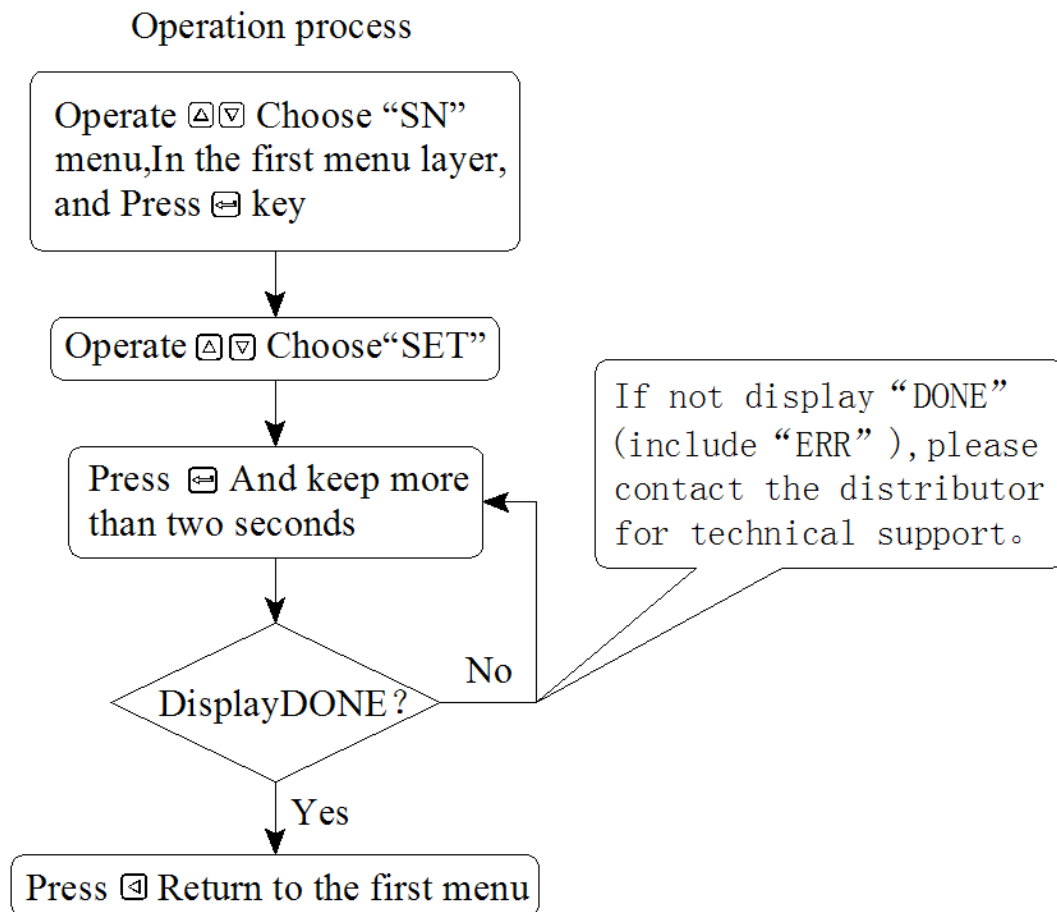

- **Sn – rd** parameter read, it means read EEPROM data in parameter area into the memory. The process will perform automatically when power on, at the beginning, the memory parameter and the EEPROM parameter is the

Chapter 3 operation and display



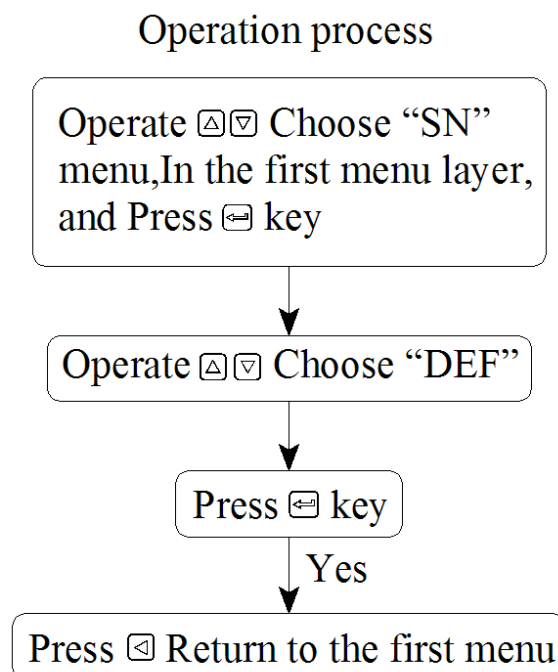

same. But when the user modified the parameter, the memory parameter value changed too. When the user is not satisfied with the modified parameter or the parameter is messy, perform the parameter read operation, the data in the ENPROM parameter area will read into the memory again and restore to the original parameters when power on at the first time.

- **Sn—SS backup parameters**
- **Sn—rS Restore backup area parameters to current memory**
- **Sn—dEF** restore default value, it means to read all the parameter default value(factory defaults) into the memory, and write in the EEPROM parameter area, next power on will use the default parameter. When the user messed the parameter and can not work properly, use this operation can restore all parameters to factory default. As different drive mode with different parameter default values, when using restore default parameters, firstly have to ensure the motor ID (parameter PN1) is correct.



Chapter 3 operation and display

3.5 F1 operation mode (panel test-run function)

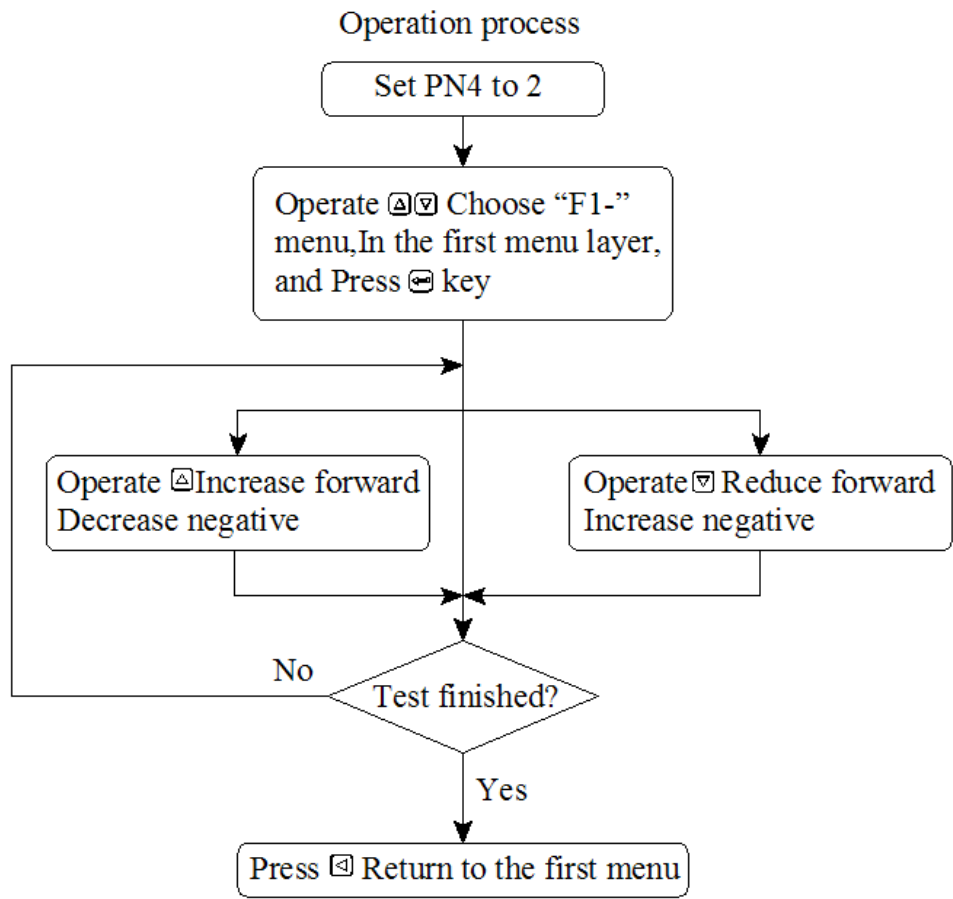

Choose “F1-” in the first layer, press  entering speed trial operation mode. Speed trial prompt is “S”, value unit is r/min. Speed command provided by keys, use  ,  can change speed command. The motor operated at the given speed.  Control the speed positive increasing,  control the speed reducing (reverse increasing). When the speed value is positive, the motor rotated in the forward direction; when the speed value is negative, the motor rotated in the reverse direction. **Note: the speed mode is a continuous motion, please ensure the motion axes with enough run distance to avoid impact and limit.**



Note: if without outside enable signal, please set PN95 parameter as 1. Or the motor won't work.

3.6 F2 run mode(JOG run test function)

Choose “F2-” in the first layer, press  entering jog operation mode. JOG run prompt is “J”, value unit is r/min , speed command provided by keys. Enter F2

operation, press  key and keep, motor run at jog speed, release the button, motor stop running, retain zero speed; press  and keep, the motor inverted running at jog speed, release the key, the motor stop running, retain zero speed, jog speed set by parameter PN22.

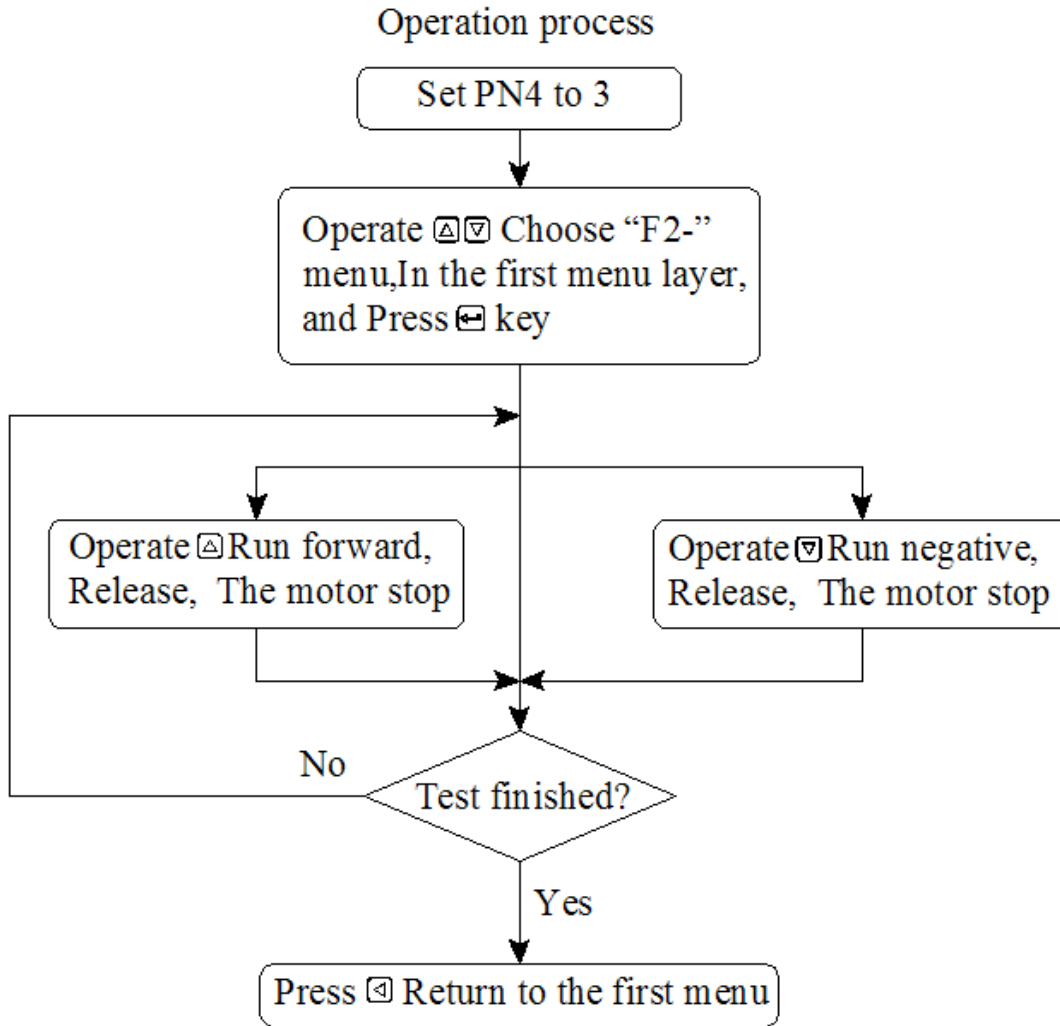

Note: if without outside enable signal, please set PN95 parameter as 1. Or the motor won't work.

3.7 Other

F4 is the photoelectric encoder zero set function, for motor manufactures use. The user can not use it.

F5 function reserve.

Chapter 4 parameter

SDD series servo with total 127 parameters can be adjusted, adjust the user parameters can meet most requirements of the user. The motor mating parameters can not be modified randomly, or there will be unpredictable results appear. Pn5-Pn16 are position control parameters, Pn17-42 are speed control parameters, Pn43-Pn50 are current control parameters, Pn51-Pn59 are I/O control parameters. Pn60-Pn96 are motor mating parameters Pn97- Pn127 are internal control parameters and communication control

p			p		
No.	Name	Value	No.	Name	Value
0	Parameter password	168	7	position feed forward low pass filter cut-off frequency	300
1	Motor ID	15	8	Position command pulse input form	0
2	Software version	1014	9	Position command pulse fractional frequency numerator	1
3	initial display status	0	10	Position command pulse fractional frequency denominator	1
4	control mode	0	11	Position control motor rotation direction	0
5	position proportion gain	800	12	Positioning completion range	20
6	position feed forward/Pulse speed control mode filter	0	13	Position out of tolerance detection range	800
14	Position out of tolerance error invalid	0	27	Back to zero accredited range	30
15	Position command smoothing filter	0	28	Feedback output pulse A/B/Z phase sequence	0
16	drive ban input invalid	1	29	Acceleration/ deceleration time constant in speed mode	200

17	speed proportion gain	400	30	Acceleration/ deceleration time constant in position mode	0
18	speed integral time constant	50	31	Position command pulse fractional frequency numerator 1	2
19	speed detection low pass filter	500	32	Internal control method selection	1
20	Rated speed	2500	33	Speed 1	-300
21	Arrive speed	500	34	Speed 2	-200
22	Jog speed	120	35	Speed 3	-100
23	Enable delayed	0	36	Speed 4	0
24	Back to zero absolute positioning pulse number	100	37	Speed 5	100
25	reserve	10	38	Speed 6	200
26	Back to zero speed	-100	39	Speed 7	300
40	Speed 8	400	54	input port high 3 reverse	0
41	numerator of the encoder output pulse	1	55	output port reverse	7
42	Denominator of the encoder output pulse	1	56	Analog instruction, direction reversal	1
43	Electric current loop proportion gain	230	57	The second position proportion gain	225
44	Electric current loop integral time constant	100	58	Reserved	0
45	Internal torque1	50	59	Z signal stretch ratio	0
46	Internal torque 2	-50	60	Reserved	
47	Internal torque 3	100	61	current rated torque	40
48	Internal torque 4	-100	62	motor rated speed	2500
49	Torque setting	300	63	Motor maximum speed	3000

Chapter 4 parameter

50	Torque command filter	100	64	motor rated current	40
51	Input port low 4 force effective	0	65	system allowed maximum overload capacity	300
52	Input port high 3 force effective	0	66	Current integral separation point	800
53	input port low 4 reverse	0	67	Analog voltage dead zone	30
68	Current command low pass filter	100	83	Key response time	20
69	Speed integral separation point	200	84	Reserved	
70	output port 1 function selection	2	85	Position error clear method	234
71	output port 2 function selection	0	86	Encoder line number	2500
72	output port 3 function selection	1	87	Encoder zero offset	2650
73	Input analog selection	0	88	Current when encoding disk is zero	60
74	Encoder type selection	0	89	Motor thermal overload	105
75	Overload torque detection point	117	90	Motor thermal overload torque	130
76	Overload point torque	200	91	Motor thermal overload time	900
77	Maximum overload time of the overload point	1000	92	Motor pole pairs	4
78	Analog voltage filter factor	100	93	Reserved	

Chapter 4 parameter

79	Speed amplifier saturation detection time	1500	94	Torque to reach output signal ratio	150
80	Blocking speed	20	95	Forced enable	0
81	Blocking confirmation time	1000			
82	Input pulse filter frequency	800	96	Reserved	
97	Internal position 0 turns	0	109	Acceleration and deceleration of the internal position	1
98	Internal position 0 pulse number	0	110	Input port 0 definition	1
99	Speed at internal position 0 positioning	1000	111	Input port 1 definition	2
100	Internal position 1 turns	0	112	Input port 2 definition	14
101	Internal position 1 pulse number	0	113	Input port 3 definition	15
102	Speed at internal position 1 positioning	1000	114	Input port 4 definition	4
103	Internal position 2 turns	0	115	Input port 5 definition	3
104	Internal position 2 pulse number	0	116	Input port 6 definition	0
105	Speed at internal position 2 positioning	1000	117	RS485 communication address	1
106	Internal position 3 turns	0	118	RS485 communication rate	5

Chapter 4 parameter

107	Internal position 3 pulse number	0	119	RS485 communication agreement	0
108	Speed at internal position 3 positioning	100	120	Position/speed integral saturation fault detection	0
121	Input port is controlled selection	0	122	Analog speed proportional gain	2048
123	Analog torque proportional gain	2048	126	High speed torque coefficient	190
124	Analog zero point	2048	127	Analog control AD mode	0
125	Torque mode speed limit	20			

4.1 All parameters function and significance detail list

No.	name	function	parameter range
0	parameter password	① password with different level, corresponding to user parameters, system parameters ② To modify the motor ID(Pn1) , must set this item to 0, user parameter password is 168. Please consult the manufacture for system parameters.	0~300
1	Motor ID	For supporting motor model. Each motor with a unique ID number, Set password Pn0 to be 0 firstly, then modify this parameter. After the setting is completed, the SN-DEF needs to be executed to be valid. Please operate this parameter with caution.	0~100
2	software ID	Reserved by the manufacturer	
3	initial display status	Choose the display status when the drive power on 0: display motor rotation speed; 1: display current position low 5;	0~20

Chapter 4 parameter

		<p>2: display current position high 5 8: display motor current; 11:display position command pulse frequency; 12:display speed command; 13:display torque command; 14:Display the rotor absolute position</p>	
4	control mode	<p>The drive control mode can be set by this parameter: 0: position control mode; 1: internal position/speed/torque control mode 2: internal speed control mode; 3: jog control mode. 4:zero mode. 5:Open loop operation mode. 6:Automatic gain adjustment mode. 7:Analog speed mode 8:Analog torque mode 9:Position and Analog speed mode. 10:Position and Analog torque model. 11: pulse speed control mode 12: Analog zero automatic adjustment (after connecting the upper computer system, Setting this parameter can automatically write the zero point of the current analog and simplify the debugging of the analog. 11 and 12 functions are available in V519 or later, and the product model suffix with D also has these two functions. The internal position/speed/torque is determined by the I/O port.</p>	0~12
5	position proportion gain	<p>Set the proportion gain of the location loop regulator. The greater the setting value, the higher the gain, and the greater the stiffness, under the same frequency command pulse condition, the location hysteresis will be less. But if the value is too big may cause oscillation or overshoot.</p>	1~1000

Chapter 4 parameter

6	position feed forward/ Pulse speed control mode filter	<p>This parameter is a multiplexing parameter (V1020). In position control mode, it is position feedforward, and the feedforward gain of the position loop is increased, and the high-speed response characteristic of the control system is improved, but it will make the position loop of the system unstable and prone to oscillation. unless high response characteristics are required, and the feedforward gain of the position loop is usually 0.</p> <p>In the pulse speed control mode, the function is the pulse speed control mode filter. Set pulse count filter level: PN6=0, corresponding sampling 8 times to average; PN6=1, corresponding to sampling 7 times to average, and so on; PN6=7 and above without filtering;</p>	0~100
7	position feed forward low-pass filter cutoff frequency	set position loop feedforward low-pass filter cutoff frequency, the high the cutoff frequency, the better the position tracking, but easy to vibrate.	1~1200
8	position command pulse input form	<p>Set the position command pulse input form 0: pulse + sign; 1: CCW pulse/CW pulse; CCW is observed from the axial of servo motor, counter clockwise rotate, it defined as forward direction. CW is observed from the servo motor axial, clockwise rotate, it defined as reverse direction. 2: A/B orthogonal signal</p>	0~2
9	position command pulse frequency division numerator	electronic gear ratio numerator	1~32767

Chapter 4 parameter

10	position command pulse frequency denominator	electronic gear ratio denominator	1~32767
11	position control motor rotate direction	0: normal; 1: direction reversed.	0~1
12	Positioning finished range	set the positioning finish pulse range under the position control; This parameter provide basis whether drive unit judgment finished positioning under the position control mode.	0~30000
13	Position tolerance detection range	set position tolerance alarm detection range; Under the position control mode, when the count value in the position deviation counters over this parameter, the servo drive unit will give position error alarm.	0~30000
14	position error invalid	0: position error alarm detection valid; 1: position error alarm detection invalid, stop detecting location error.	0~1
15	position command smoothing filter	smooth filtering command pulse, with exponential form acceleration and deceleration, numerical value means time constant; The filter will not lose input pulse, but there will be command delay phenomenon; When set to 0, the filter doesn't work.	0ms~2000 0×0.1ms
16	drive ban input invalid	0: CCW、CW input ban valid; 1: cancel CCW、CW input ban.	0~1
17	speed proportion gain	Set the speed loop regulator proportion gain. 1.The greater the setting value, the higher the gain, and the greater stiffness. 2.The greater the load inertia, the greater the setting value.	5Hz ~2000Hz

Chapter 4 parameter

18	speed integral time constant	Set speed loop regulator integral time constant; 1.The smaller the set value, the faster integral speed and the greater stiffness. 2.The greater load inertia, the greater of set value. At the frequent start-stop small power occasion, the set value is small to prevent overshoot.	1ms ~1000ms
19	speed detection low pass filter	set speed test low pass filter characteristic; 1. The smaller value, the low cutoff frequency, the smaller of the motor noise. If the load inertia is large, could reduce the setting value. If the value is too small may cause to low response and vibration. 2. The larger the value, the higher the cutoff frequency, the speed response faster. If high speed response needed, could increase the setting value.	1%~500%
20	rated speed	rated speed of the motor	0~ 6000
21	reach speed	Set the speed value when input signal reach effective	0~3000
22	jog speed	Set jog speed.	-3000 ~3000 r/min
23	Enable delay		0-1000ms
24	Orientation absolute positioning pulse count	Precise position when external triggering orientation control Actual operation position is set value *2	0-65535
25	reserve	reserve	
26	Orientation speed	The speed when external triggering orientation control, by setting plus or minus speed to decide rotation direction when positioning.	0~3000 r/min
27	Orientation complete range	Identified range when external triggering orientation control	0-10000
28	Feedback output pulse A/B/Z phase sequence	Drive motor output pulse A/B/Z phase sequence during initial power-up 0: Normal; 1: Phase A is inverted; 2: Phase B is inverted; 3: A/B is reversed when it is the same; 4:	0-7

Chapter 4 parameter

		Phase Z is inverted; 5: A/Z is reversed simultaneously; 6: B/Z is also Inverse; 7: A/B/Z is also reversed	
29	Acceleration/ deceleration time constant in speed mode	Set value means the motor acceleration/ deceleration time from 0r/min~1000r/min. Acceleration and deceleration are linear. Only used for speed control mode, it is invalid for position control mode;	0ms~32767ms
30	Acceleration/ deceleration time constant in position mode	It means that when the motor is accelerating and decelerating from 0~1000r/min, the acceleration and deceleration characteristics are linear. When set to 0, position acceleration and deceleration have no effect. When set to other values, it can effectively reduce the impact of position loop commutation and acceleration and deceleration, and the operation is more stable. It is only used in position mode.	0ms~32767ms
31	Position command pulse frequency second numerator	Position control the second gear ratio numerator	1~65536
32	Internal control method selection	<ol style="list-style-type: none"> 1. Internal speed and external pulse position switching 2. Internal torque and external pulse position switching 3. Internal position and external pulse position switching <p>It is only necessary to define the corresponding input port as function 19 when switching. If only internal speed or internal torque or internal position is used, the corresponding input port is defined as function 19 when there is no need to switch functions. At the same time, the input port is permanently set</p>	0~3

Chapter 4 parameter

		<p>high or low according to the actual situation.</p> <p>When working in multiple modes, you need to observe what control mode is currently in progress. You can check un-11 to determine the working status and facilitate debugging.</p>																																					
33	Speed 1	<p>Internal speed control mode: by external I/O point status to control the speed. For example:</p> <table style="margin-left: auto; margin-right: auto;"> <tr> <td></td> <td>SC1</td> <td>SC2</td> <td>SC3</td> </tr> <tr> <td>Pn33:</td> <td>OFF</td> <td>OFF</td> <td>OFF</td> </tr> <tr> <td>Pn34:</td> <td>ON</td> <td>OFF</td> <td>OFF</td> </tr> <tr> <td>Pn35:</td> <td>OFF</td> <td>ON</td> <td>OFF</td> </tr> <tr> <td>Pn36:</td> <td>ON</td> <td>ON</td> <td>OFF</td> </tr> <tr> <td>Pn37:</td> <td>OFF</td> <td>OFF</td> <td>ON</td> </tr> <tr> <td>Pn38:</td> <td>ON</td> <td>OFF</td> <td>ON</td> </tr> <tr> <td>Pn39:</td> <td>OFF</td> <td>ON</td> <td>ON</td> </tr> <tr> <td>Pn40:</td> <td>ON</td> <td>ON</td> <td>ON</td> </tr> </table>		SC1	SC2	SC3	Pn33:	OFF	OFF	OFF	Pn34:	ON	OFF	OFF	Pn35:	OFF	ON	OFF	Pn36:	ON	ON	OFF	Pn37:	OFF	OFF	ON	Pn38:	ON	OFF	ON	Pn39:	OFF	ON	ON	Pn40:	ON	ON	ON	-6000 ~6000 r/min
	SC1		SC2	SC3																																			
Pn33:	OFF		OFF	OFF																																			
Pn34:	ON		OFF	OFF																																			
Pn35:	OFF		ON	OFF																																			
Pn36:	ON		ON	OFF																																			
Pn37:	OFF		OFF	ON																																			
Pn38:	ON		OFF	ON																																			
Pn39:	OFF	ON	ON																																				
Pn40:	ON	ON	ON																																				
34	Speed 2	-6000 ~6000 r/min																																					
35	Speed 3	-6000 ~6000 r/min																																					
36	Speed 4	-6000 ~6000 r/min																																					
37	Speed 5	-6000 ~6000 r/min																																					
38	Speed 6	-6000 ~6000 r/min																																					
39	Speed 7	-6000 ~6000 r/min																																					
40	Speed 8	-6000 ~6000 r/min																																					
41	numerator of the encoder output pulse	Every loop feedback pulse encoder output after through the gears within the drive unit.	1~65536																																				
42	Denominator of the encoder output pulse	Every loop feedback pulse encoder output after through the gears within the drive unit.	1~65536																																				
43	current loop proportion gain	1.The higher the set value, the greater the gain, the current tracking error is smaller. But too much gain will produce vibration or noise, 2.it related with the servo motor, 3. Independent of load	1 ~ 500																																				
44	current loop integral time constant	1.The smaller the set value, the faster the integral speed, and the current tracking error is smaller. But too small integral will produce vibration or noise.2. It related with servo motor, 3. Independent of load.	1~10000																																				

Chapter 4 parameter

		4. Try to set larger value under the condition of the system without vibration.	
45	Internal torque 1	Internal torque control mode: the size of the torque is controlled by the status of the external I/O point. For example: T0 T1 Pn45: OFF OFF Pn46: ON OFF Pn47: OFF ON Pn48: ON ON	0%~300%
46	Internal torque 2		-300%~0%
47	Internal torque 3		0%~300%
48	Internal torque 4		-300%~0%
49	torque set	internal speed, jog speed torque	0~300%
50	torque command filter	1. Setting the torque command filter characteristics can restrain the vibration which produced by torque (the motor give out sharp vibration noise). 2. The smaller of the value, the lower of the cutoff frequency, the smaller noise produced by motor. If the load inertia is very big, can reduce the set value properly. If the value is too small, may result in slow response and may cause instability.	1%~500%
51	Input low 4 enforce effective	The lower four bits of the input signal are forced ON. Invert the binary, set the value to decimal, for example: 1 (0001) the lowest bit is forced to be valid, 2 (0010) the second bit is forced to be valid, 4 (0100) the third bit is forced to be valid, 8 (1000) the fourth bit is forced to be valid.	0~15
52	Input high 3 enforce effective	Input signal high 3 enforce ON	0~7
53	input low 4 reverse	input signal low 4 reverse, used to match the electrical level of the input signal contact spot	0~15
54	input high 3 reverse	input signal high 3 reverse, used to match the electrical level of the input signal contact spot	0~7
55	output port reverse	Output signal reverse, used to match the electrical level of the output signal	0~15

Chapter 4 parameter

56	Analog instruction, direction reversal	Analog instruction, direction reversal. Switch direction.	0~1
57	The second position proportion gain	The function is same with PN5, which parameter used as position proportion gain in system, is determined by external I/O, in default situation, with PN5 as system internal position proportion gain.	1-65536
58	Reserved	Reserved	
59	Z signal stretch ratio	When using a host computer such as a PLC, if the Z signal reception is difficult, this parameter can be used to widen the output Z signal to facilitate the use of the upper computer. When set to 0, no stretch function	0-31
60	Reserved	Reserved	
61	motor rated torque	set motor rated torque	1~1000
62	motor rated speed	Set motor rated speed.	0~6000 r/min
63	Motor maximum speed	Set motor maximum speed	0~6000 r/min
64	motor rated current	Set motor rated current. Set value is valid.	1~500× 0.1A
65	system allowed maximum overload capacity	Set system allowed maximum overload multiple	0~300%
66	Current integral separation point	Current error over the set value, the current loop from PI change to P, value is the percentage of rated current	0~800%
67	Analog voltage dead zone	Analog voltage dead zone AD value, set this value reasonable, with the absence of the input voltage, and solve the motor rotation produced by the zero	0~4096

Chapter 4 parameter

		voltage wave.	
68	current command low pass filter	Set current command low pass filter cutoff frequency. Used to limit the current command frequency band, avoid the current shock and vibration, and make the current response stably.	1~1500HZ
69	Speed integral separation point	When speed error over the set value, the speed change from PI to P	0~300
70	Output port 1 function selection	Set output port 1 function: 0: break output function 1: servo alarm output 2: position reach 3: speed reach 4: servo ready 5: back to zero complete 6: out of torque reach 7: Motor stall signal output	0-7
71	Output port2 function selection	Set Output 2 function: refer to Pn70	0-7
72	Output port3 function selection	Set output 3 function: refer to Pn70	0-7
73	Input analog selection	0: -10V~10V voltage analog input, the positive and negative voltage determines the direction 1: 0V~10V voltage analog input, IO input port function is set to 22, 23, two channels of signal on and off determine different directions 2: -10V~0V voltage analog input, IO input port	0-3

Chapter 4 parameter

		<p>function is set to 22, 23, two channels of signal on and off determine different directions</p> <p>3: 0V~10V voltage analog input, the IO input port function is set to 22, and the direction is determined by the on-off of a signal</p> <p>The above functions are in the analog speed and analog torque mode</p> <p>Can be used</p>	
74	Encoder type selection	<p>0; 15core 2500p normal encoder</p> <p>1; 9core line 2500p encoder</p>	0~1
75	Overload torque detect point	<p>Set the start torque value of the overload protection, rated percentage.</p> <p>When the present torque over this value, the system internal overload counter work, counter exceeds, system output overload alarm.</p>	0-300%
76	Overload feature point torque	<p>Set overload point torque, This parameter and Pn77 make up the overload characteristic of the motor together. Set by the motor overload characteristic parameters. Note Pn76» Pn75</p>	0-300%
77	Maximum overload time of the overload point	refer to Pn76	0-3000×10ms
78	Analog voltage filter coefficients	<p>Analog voltage filter coefficient, the larger the setting, the more stable the speed;</p> <p>Set PN78 < 10, and the filtering result is 1/Pn78;</p> <p>Set PN78 > 10, the filtering result is 1/Pn78² ;</p> <p>Set PN78=10, and the filtering result is the same as the original one. (V1020)</p> <p>The occasions <10 are occasions that require quick response. Applications greater than 10 are used as the input module voltage fluctuation is unstable, but the</p>	0-1000

Chapter 4 parameter

		motor speed is required to be stable, but there is no potential for fast response. In the case of speed regulation.	
79	Speed amplifier saturation time	When the continuous saturation time of the system's internal speed regulator exceeds this value, a speed saturation alarm is generated. Used to prevent mechanical jamming or other reasons caused the continuous current larger.	0-3000×10 ms
80	Blocking speed	When the torque control, the motor is blocked after the value is lower than the set value.	0~100
81	Blocking confirmation time	Output blocking signal from the time when the lock is confirmed to the set value When the stall signal is enabled, the output port function is set to 7 to be effective.	0.1ms
82	Input pulse filtering frequency	Set input pulse pass frequency, unit 1 means 1KHZ, set at 500, means the system maximum pass frequency is 500KHZ.	1-10000
83	Key period	The key response time	2~200
84	Reserved	Reserved	
85	Position difference removal method/pulse speed instruction filter	0: no enable status, position deviation command pulse accumulation reset 1: no enable status, position deviation command pulse accumulation is not reset, count continuously. V519 version and product model with D version, this parameter function is pulse speed command filter;	0-500
86	Encoder line number	Encoder line number	1-65536
87	The encoder zero offset	The encoder zero division angle with U.	1-65536
88	Encoder current when reset	Set current value when the encoder reset, the percentage cannot too big to avoid motor	0-300%

Chapter 4 parameter

		overheating	
89	Motor thermal overload torque detect point	Thermal overload use I*I*T calculate method	10-300%
90	Motor thermal overload torque	Set this parameter bigger than Pn89	10-300%
91	Motor thermal overload time	Set thermal overload maximum time	0-1000S
92	motor pole pairs	Set servo motor pole pairs, different manufacture and different model motor may with different pole pairs, cannot change this parameter randomly	1~36
93	Position gain attenuation coefficient	Set the position gain attenuation factor.	1~100× 0.1A
94	Torque reached output signal ratio	Simulation control torque reaches the set value, torque reach output signals effectively. The value is the percentage of rated torque.	0~300%
95	Force enable	0: servo enable is controlled by external I/O 1: automatic servo enable when forced power on, do not need to connect external signal	0~1
96	Reserved	reserve	
97	Internal position 0 turn	Set internal position 0 precise position When the internal position control: target position	-65535~65535
98	Internal position 0 pulse	determine by these 2 parameters, position 0= Pn97*10000+ Pn98 For example: Pn97=2 Pn98=1000 Indicates internal position movement =2*10000+1000=21000unit	1~65535
99	Speed at internal position 0 positioning	The speed of positioning to internal position 0	0~3000 r/min

Chapter 4 parameter

100	Internal position 1 turn	Set internal position 1 precise position	-65535~65535
101	Internal position 1 pulse	Refer to Pn97 Pn98	1~65536
102	Speed at internal position 1 positioning	The speed of positioning to internal position 1	0~3000 r/min
103	Internal position 2 turn	Set internal position 2 precise position	-65535~65535
104	Internal position 2 pulse	Refer to Pn97 Pn98	1~65535
105	Speed at internal position 2 positioning	The speed of positioning to internal position 2	0~3000 r/min
106	Internal position 3 turn	Set internal position 3 precise position	-65535~65535
107	Internal position 3 pulse	Refer to Pn97 Pn98	1~65535
108	Speed at internal position 3 positioning	The speed of positioning to internal position 3	0~3000 r/min
109	Acceleration of the internal position	Acceleration and deceleration time when internal positioning, the greater the value, the faster the acceleration.	0~2000
110	Input port 0 definition	Servo enable function, this input port cannot define other functions	1
111	Input port 1 definition	Used to define the function of the input port, for the convenience of customers The set value and functions as follows: 0: no definition, no function 1: servo enable 2: alarm clear 3: input pulse prohibited 4: position deviation counter reset	0~23

Chapter 4 parameter

		<p>5: speed command input 0 6: speed command input 1 7: speed command input 2 8: Input point controls motor direction reversal 9: position gain switch 10: position gear ratio numerator switch 11: Zero speed clamp 12: torque command input 0 13: torque command input 1 14: positive drive prohibited 15: reverse drive prohibited 16: internal position command 0 17: internal position command 1 18: internal position running start 19: internal control method option 0 20: internal control method option 1 21: directional control functions 22: Voltage analog input inversion 23: Voltage analog input forward</p> <p>Note: V1014 version or above, internal/analog speed and pulse position switching; internal/analog torque and pulse position switching; after setting PN4 PN32, only need to set the switching input point function to 19</p>	
112	Input port 2 definition	Refer to Pn111	0-23
113	Input port 3 definition	Refer to Pn111	0-23
114	Input port 4 definition	Refer to Pn111	0-23
115	Input port 5 definition	Refer to Pn111	0-23

Chapter 4 parameter

116	Input port 6 definition	Refer to Pn111	0-23
117	Communicate address	More than one drive communicate, set the station number	0-127
118	Communication rate	Communication rate 0: 4800 1: 9600 2: 19200 3: 38400 4: 57600 5: 115200	0-5
119	Transport protocol	Transport protocol, use RTU mode 0: 8 O 1 (MODBUS, RTU) 1: 8 E 1 (MODBUS, RTU) 2: 8 N 2 Note: 8 means 8 bits data, E means 1 even O means 1 odd 1 means 1 end bit	0-2
120	position/speed integral saturation fault detect	0: detect integral saturation fault 1: do not detect integral saturation fault	0-1
121	Input port is controlled section	Set I/O port as controlled object 0: controlled by external input terminal CN1 1: controlled by RS485 communication control	0-1
122	Simulation speed proportional gain	Certain input voltage, the bigger of the set values, the higher speed got.	0-4096
123	Simulation torque proportional gain	Certain input voltage, the bigger of the set values, the bigger of the torque got.	0-4096

Chapter 4 parameter

124	Simulation zero	Set up to simulate zero voltage, adjust the symmetry of positive and negative direction of speed or torque.	0-4096
125	The speed limit of torque mode	Torque control mode to limit the speed	0-4000
126	High speed torque coefficient	Ascension of coefficient of high speed torque	0-500
127	Analog AD conversion method	<p>Analog control AD conversion mode:</p> <p>0: When the voltage is higher than the dead zone, start to accelerate and deceleration from 0.</p> <p>1: When the voltage is higher than the dead zone, the speed starts to jump to the speed corresponding to the dead zone voltage start acceleration and deceleration.</p> <p>2: When the voltage is lower than the dead zone, add position control and lock the current position.</p>	0-2

4.2 parameter adjust diagram model

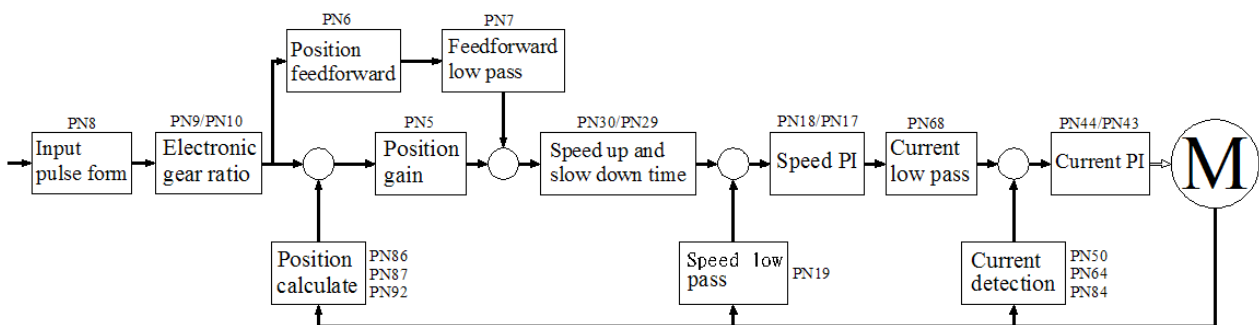

4.3 Description of Servo key parameters

As the default motor mating parameters has been optimized, therefore, the parameters (except electronic gear) do not need to adjust in most applications and can be used directly. But the actual mechanic is complex. If abnormality appear or needs high response when adjusting, then need to adjust the parameters to meet requirement. The adjustment principle is first current loop, second speed loop, last position loop.

The current loops do not need to adjust except for individual situation. The too fast speed response results in current shock and AL11 alarm. It can adjust PN64 to solve.

Speed loop: If high speed response needed, can increase PN17 or decrease PN18. However, the PN17 setting too large will cause vibrate. In the occasion of too big load inertia, if the load motor park unstably when decelerating and wag from side to side, need to increase PN18 to solve.

Position loop: If high location response needed, can increase PN5. Some occasions can increase PN6 to meet requirement. But PN5 PN6 is too large will cause vibrate. The setting precondition is to adjust PN5 prior, only in the short distance and high response occasion can use PN6.

electronic gear ratio: 1) if calculate from rotate speed angle, the below formula can be used

$$f \times (PN9/PN10) = 131072$$

in which f denotes the upper computer pulse, unit is KHZ/circle

If knows the pulse number from the upper computer and make the motor or load turn a circle, the gear ratio set value can be calculated with the above formula.

Chapter 4 parameter

2) calculate according to the position accuracy directly

$$(\text{lead/pulse equivalent}) \times (\text{PN9/PN10}) = 10000$$

For example: screw lead is 5mm, motor and screw lead connected directly, the motor rotates a circle, the load move 5mm. If the accuracy need 0.001mm, there are 5000 pulse needed for motor rotating a circle; that is: PN9=10, PN10=5

Pulse input form: support pulse with direction and double pulse (positive and negative pulse), set PN8

4.4 parameter adjusting steps in actual application

In the process of adjusting or application, if there is vibration, noise or cannot reach the control accuracy, can adjust system parameters and meet the control requirement as the following methods.

When the motor is in static locking state, if there is vibration or sharp noise, please decrease parameter Pn43; set this parameter as large as possible under the condition without vibration. The larger the parameter, the better the current tracking effect and the faster the motor response; but too large parameter results in vibration or noise.

(1) : speed control mode parameters adjustment

1) [speed proportion gain] (parameter Pn17) set value, as large as possible under the condition without vibration. Generally, the larger of the load inertia, the larger of the set value.

2) [speed integral time constant] (parameter Pn18) set value, try to set as small as possible according to the given condition. If the set value is too small, the response speed will be increased, but easy to vibration. Try to set the value as small as possible under the condition of no vibration. If the value is too large, when the load changed, the speed will change bigger.

(2) : position control mode parameter adjustment

1) according to the above method to set proper [speed proportion gain] and [speed integral time constant].

Chapter 4 parameter

2) [position feed forward gain] (parameter Pn6) set to 0%.

3) [position proportion gain] (parameter Pn5) set value, set as large as possible in the stable range. When the parameter is large, the position tracking will be good and hysteresis error is small, but easy to produce vibration when stop positioning. When the parameter is small, the system in stable state, but the position tracking become worse and hysteresis error become larger.

4) If position tracking requirement quite high, can increase Pn6 set value; but if it is too big, can lead to overshoot.

Chapter 5 operation and adjustment

5.1 special attention during debugging:

- 1) (large/medium-power model suffix are K8) servo drive Connect the three phase AC 220V power to input terminal. three phase connect L1、L2、L3, single phase connect L2、L1.
- 2) (small power model suffix is K7) servo drive single phase connect L、N.
- 3) motor power line U, V, W, PE, the sequence cannot reverse.
- 4) Drive connection as above. The wrong connection may cause burning, motor does not run, alarm etc. please check the line connection correct or not.

5.1.1 Power on sequence

- 1) When the power supply switch on, servo alarm signal output in 1S, after 1.5S signal output ready, after 10MS response to enable signal, less than 10MS motor excitation lock; waiting for running.

5. 2 Position control mode

- 1) Connect control circuit power and main circuit power, the display of the drive lighten. If there is alarm, please check the line connection.

- 2) Set below parameters:

parameter No.	parameter name	definition	Set value
Pn4	Control mode	0: position mode 1:internal position mode	0
Pn8	Position command pulse input mode	0: Single pulse 1: double pulse 2: A/B orthogonal pulse	0
Pn9	Gear ratio numerator		1
Pn10	Gear ratio denominator		1
Pn95	Servo enable	0: external enable 1: force enable	1

Chapter 5 operation and adjustment

3) Confirm there are no alarm and any abnormal situation, make enable servo (SON) ON, at this time, the motor motivated, in a state of zero velocity. If enable signal cannot connect wire, set Pn95 as 1 can make enable motor automatically.

4) Adjust the pulse frequency of the input signal; make the motor running according to command.



5.3 speed trial run mode

1) Connect control circuit power and main circuit power, the display of the drive lighten. If there is alarm, please check the line connection.

2) Set parameter as below:

parameter No.	parameter name	definition	Set value
Pn4	Control mode	0: position mode 1: internal position mode 2: trial run	2
Pn95	Servo enable	0: external enable 1: force enable	1

3) Confirm there are no alarm and any abnormal situation, make enable servo (SON) ON, at this time, the motor motivated, in a state of zero velocity. If enable signal cannot connect wire, set Pn95 as 1 can make enable motor automatically.

4) Through key operation enter F1 speed trial operation mode, speed trial operation prompt “S“, value unit is r/min, system in the speed trial mode, speed command provided by key, use   change speed command, the motor run based on the setting speed.

5.4 Jog operation

1) Connect control circuit power and main circuit power, the display of the drive lighten. If there is alarm, please check the line connection.

2) Set parameter as below:

Chapter 5 operation and adjustment

parameter No.	parameter name	definition	Set value
Pn4	Control mode	0: position mode 1: internal position mode 2: trial run 3: jog run	3
Pn95	Servo enable	0: external enable 1: force enable	1

3) Confirm there are no alarm and any abnormal situation, make enable servo (SON) ON, at this time, the motor motivated, in a state of zero velocity. If enable signal cannot connect wire, set Pn95 as 1 can make enable motor automatically.

4) Through key operation enter F2 speed trial operation mode, JOG run prompt “J”, value unit is r/min, system in the speed control mode, speed and direction determined by parameter Pn22, press ▲ motor running according to the speed and direction which determined by Pn22, press ▼ motor running opposite direction according to the given speed.

5.5 Internal position/speed/torque control mode

1) Connect control circuit power and main circuit power supply, the drive display light. If there is alarm, please check the line connection.

2) Set parameter as below:

parameter No.	parameter name	definition	Set value
Pn4	Control mode	0: position mode 1: internal position mode	1
Pn95	Servo enable	0: external enable 1: force enable	1
Pn111	IN1 definition	Define as position trigger	18
Pn112	IN2 definition	Define as orientation start	21
Pn113	IN3 definition	Define internal mode selection 0	19

Chapter 5 operation and adjustment

Pn114	IN4 definition	Define internal position 0	16
Pn115	IN5 definition	Define internal position 1	17
Pn116	IN6 definition	Define internal mode selection 1	20

3) Power off, re-up electricity, Confirm there are no alarm and any abnormal situation, make enable servo (SON) ON, at this time, the motor motivated, in a state of zero velocity. If enable signal cannot connect wire, set Pn95 as 1 can make enable motor automatically.

4) By switching the status of IN3 IN6 can switch under the mode position, speed and torque

Corresponding method as follows:

IN3. IN6 input signal status	Internal control mode
OFF OFF	position
ON OFF	speed
OFF ON	torque

5) By switching the status of IN4 IN5 can realize 4 point positioning movement, the speed of 4 point positioning movement and accurate position set by Pn97-Pn109.

IN4 IN5 input signal status	Internal control mode
OFF OFF	Position A
ON OFF	Position B
OFF ON	Position C
ON ON	Position D

Chapter 5 operation and adjustment

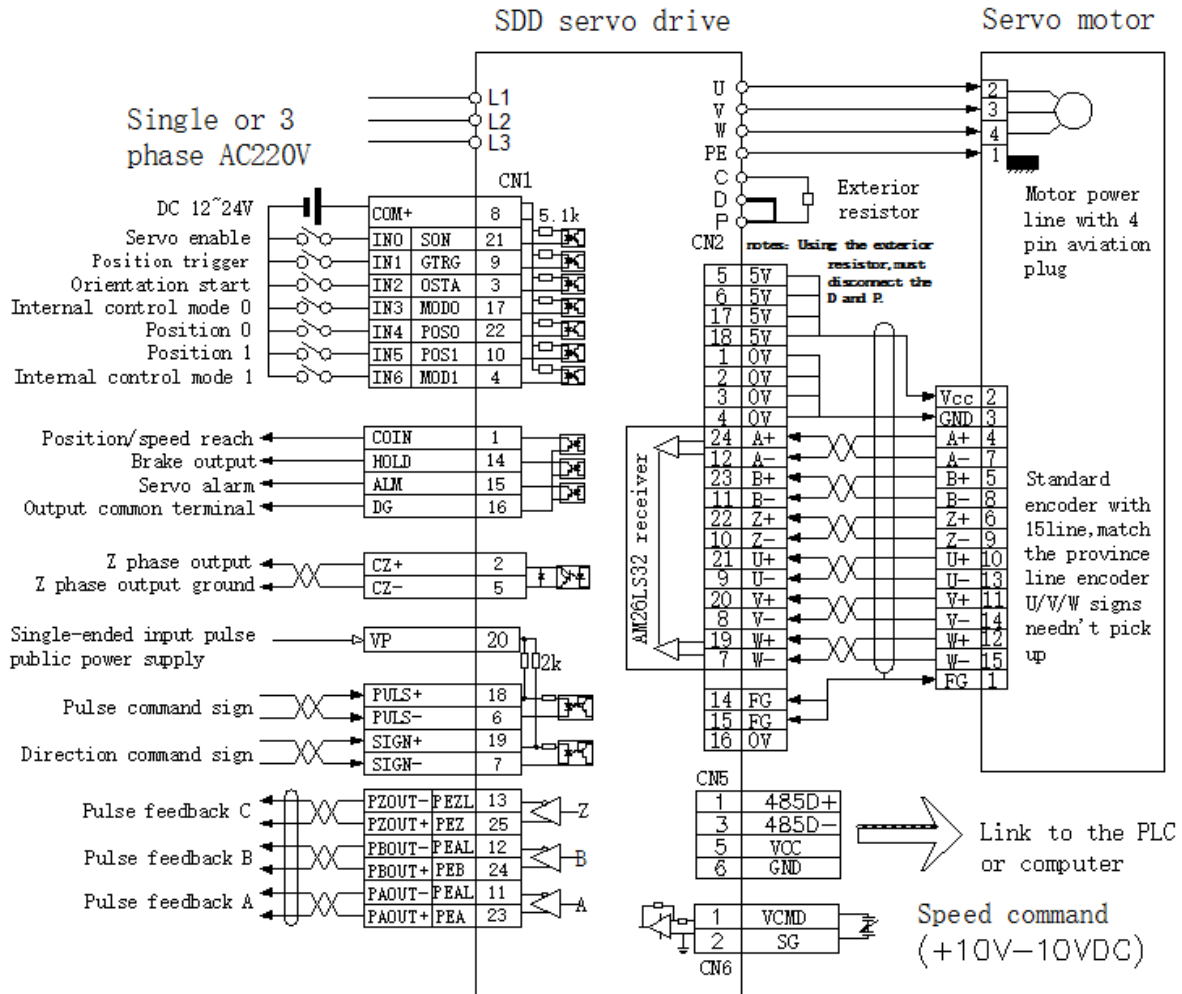

5.5.1 Internal position application example

Use internal position control to realize the belowing 4 point movement mode.

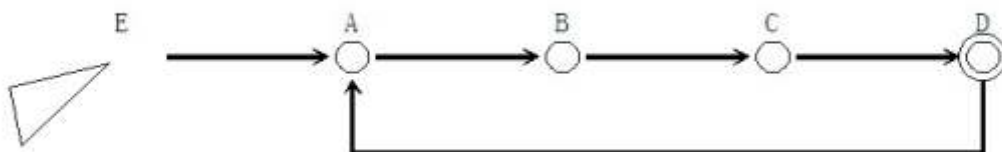

Chapter 5 operation and adjustment

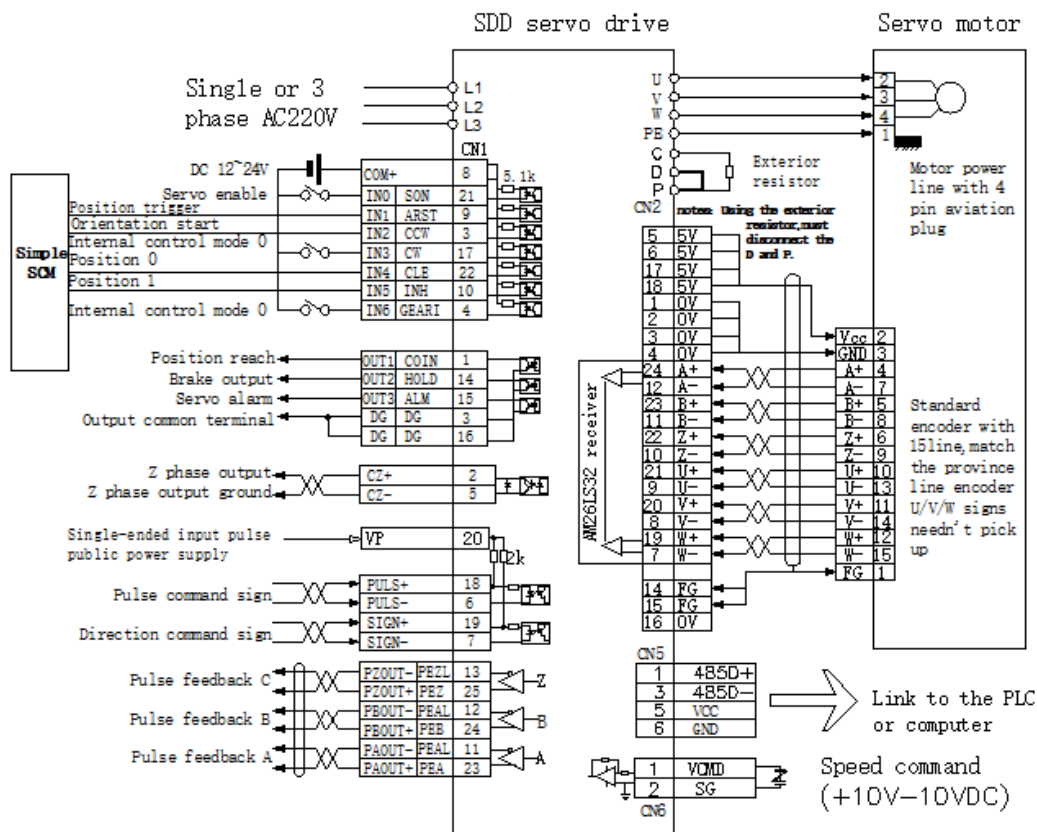

Internal position control applications Electrical wiring diagram

The framework consists of one of the simplest microcontrollers and this servo system. The one-chip computer is used to send three control signals to the servo to trigger the servo's internal position control mode and the precise positioning of the operation. This example can be omitted high-end computer such as: PLC motion controller. At the same time, interference during pulse transmission is eliminated. More accurate servo positioning. In the case of repeated positioning within four points, it has a very economical cost and excellent control performance.

Control detailed description: IN3 IN6 signal connect with OV signal, it means choose internal position control mode. IN0 signal connect with OV signal, it means choose servo automatic enable after power on. Singlechip control process: system power on, the singlechip send a low level signal to servo IN2 signal, start servo and orientation back to the origin point A. carry out every time when starting up, it means wherever the origin position is, will be back to

Chapter 5 operation and adjustment

the fixed position before work. When servo position back to point A, the singlechip send two level signal to servo IN4 IN5 so as to control servo move from point A to point B, C, D and back to point A, complete a circulation. Every time start and trigger are done by IN2 signal. Rising edge effective.

This system has the characteristics of simple control, accurate positioning, and strong anti-interference ability. The run speed and precise position set by Pn97- Pn109. The parameters needed to be set as below:

parameter No.	parameter name	definition	Set value
Pn4	Control mode	0: position mode 1:internal position mode	1
Pn111	IN1 definition	Define as position trigger	18
Pn112	IN2 definition	Define as orientation start	21
Pn113	IN3 definition	Define internal mode selection 0	19
Pn114	IN4 definition	Define internal position 0	16
Pn115	IN5 definition	Define internal position 1	17
Pn116	IN6 definition	Define internal mode selection 1	20
Pn 97	Internal position 0 turns		Set relevant parameters according to the actual ABCD four coordinates
Pn 98	Internal position 0 pulse		
Pn 99	Internal position speed of 0 positioning		
Pn 100	Internal position 1 turns		
Pn 101	Internal position 1 pulse		
Pn 102	Internal position speed of 1 positioning		
Pn 103	Internal position 2 turns		
Pn 104	Internal position 2 pulse		
Pn 105	Internal position speed of 2 positioning		

Pn 106	Internal position 3 turns	
Pn 107	Internal position 3 pulse	
Pn 108	Internal position speed of 3 positioning	
Pn 109	Acceleration and deceleration time constant of internal control	

5.5.2 internal speed application example

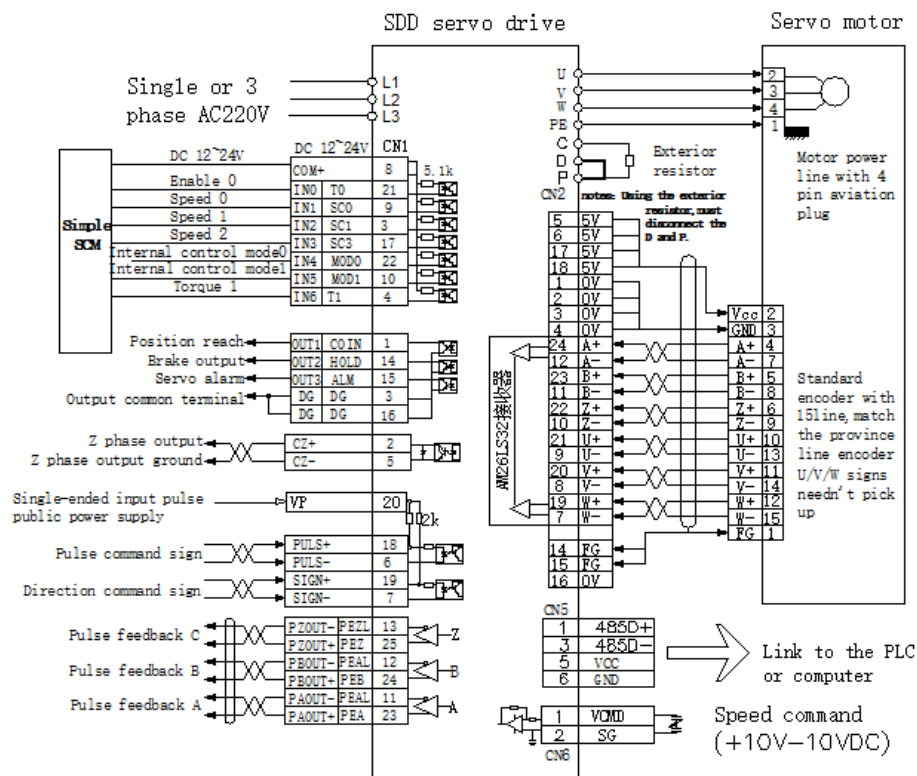

Internal speed and torque mix control application electric wiring diagram

As shown in the figure, according to this example, 8 kinds of internal speed control and 2 types of internal torque control can be realized. And can be switched to each other. IN1 IN2 and IN3 are internal speed switch signals. Internal speed value set by parameters Pn33- Pn40. IN4 IN5 are internal speed and torque mode switch signals. Internal torque value set by parameters Pn45- Pn46.

Chapter 5 operation and adjustment

Servo relevant parameters set as below:

parameter No.	parameter name	definition	Set value
Pn4	Control mode	0: position mode 1: internal position mode	1
Pn95	Servo enable	0: external enable 1: force enable	1
Pn110	IN0 definition	Servo enable	1
Pn111	IN1 definition	Define as speed 0	5
Pn112	IN2 definition	Define as speed 1	6
Pn113	IN3 definition	Define as speed 2	7
Pn114	IN4 definition	Define internal selection mode 0	19
Pn115	IN5 definition	Define internal selection mode 1	20
Pn116	IN6 definition	Define as moment of force 1	13
Pn 33	Speed 1		Set relevant parameters according to the actual run speed and moment of force
Pn 34	Speed 2		
Pn 35	Speed 3		
Pn 36	Speed 4		
Pn 37	Speed 5		
Pn 38	Speed 6		

Pn 39	Speed 7		requirements
Pn 40	Speed 8		
Pn 45	Internal torque 1		
Pn 46	Internal torque 2		

5.6 Servo features application

Servo start orientation function

when input port set as servo start orientation function, only set input signal as ON, the orientation function will start automatically(except torque control mode). Rotate direction of orientation is determined by Pn 26. precise position of orientation is determined by Pn 24 Pn 25. if set single turn orientation, the precise position is determined by Pn 24; if set multi turns orientation, the precise position is determined by $(Pn\ 25 * 131072) + Pn\ 24$. when input signal OFF, orientation function turnoff.

5.6.1 Position gear ratio switch function

When input port set as position gear ratio switch function, and input signal set as ON, the system use parameters of Pn 31 as present input pulse electronic gear. When input signal set as OFF, the system use the parameters of Pn9 as present input pulse electronic gear. This function mainly used to the occasions that dynamic electronic gear ratio needed.

5.6.2 Position gain switch function

When input port set as position gain switch function and input signal set as ON, the system use the parameters of Pn57 as present position loop control gain. When input signal set as OFF, the system use parameters of Pn5 as present position loop control gain. This function mainly used to the occasions that dynamic position gain needed.

5.6.3 Input pulse command filter

In the practice industry application sit, there is much interference, the input pulse command may caused the servo counting error because of the external

Chapter 5 operation and adjustment

interference. Therefore, affect the servo repositioning accuracy. Setting this filter can prevent the interference into the servo system. Improve the ability of anti-interference of the system.

The relationship of set value and the passable frequency as below:

Pn 82 set value	The maximum passable pulse frequency
1000	1MHZ
500	500KHZ
250	250KHZ
100	50KHZ

5.7 Simulation speed control mode

Input analog voltage signal by the CN6, and set PN4 to be 7, Servo work in analog speed. We can control the speed of motor by adjust the size of voltage.

5.8 Simulation torque control mode

Input analog voltage single by the CN6, and set PN4 to be 8. Servo work in analog torque. We can control the torque of motor by adjust the size of voltage.

5.9 Position and simulation speed hybrid control mode

Input analog voltage single by CN6, and set PN4 to be 9, pulse command input from the control port. Servo work in position and analog speed hybrid control mode. Can be realized the switch between position and analog speed by I/O port control. Typical applications such as machine main axis.

5.10 Position and simulation torque hybrid control mode

Input analog voltage single by CN6, and set PN4 to be 10, pulse command input from the control port. Servo work in position and analog torque hybrid control mode. Can be realized the switch between position and analog torque by I/O port control. Typical applications such as: Injection molding machine, screw machine.

Chapter 7 Alarm and processing

If the servo with failure in use, the display will show: Al—xx, if there are various alarms, different alarm message will display by turns. For fault diagnosis, please operate according to the content of this chapter, get rid of the corresponding fault and can be put into use again.

7.1 Alarm list

alarm code	alarm name	alarm reason
AL-0	normal	
AL-1	overspeed	servo motor speed exceeds the set value
AL-2	main circuit overvoltage	main circuit voltage too high
AL-3	main circuit undervoltage	main circuit voltage too low
AL-4	Position out of tolerance	motor with deviation over parameter Pn13 setting value
AL-6	speed amplifier saturation	speed amplifier saturated a long time
AL-9	encoder abnormal	encoder with break line or short circuit
AL-11	excess current 1	IPM module output current is too large
AL-12	excess current 2	DSP detection current is too large
AL-13	excess load	servo output torque over the allowed value
AL-14	braking abnormal	braking circuit abnormal
AL-15	encoder count abnormal	encoder AB signal abnormal
AL-16	motor thermal overload	Motor overload long time
AL-20	EPROM error	servo inside EEPROM read-write abnormal
AL-24	FPGA communication abnormal	FPGA communication abnormal
AL-32	encoder UVW invalid	Encoder sign error
AL-45	ADC error	ADC error
AL-46	servo power sign abnormal	servo power sign abnormal

7. 2 Alarm processing method

alarm code	alarm name	reason	disposal method
AL-1	overspeed	input command pulse frequency is too high	Set input command pulse correct
		input electronic gear ratio is too large	set Pn9 Pn10 parameter correct
		encoder zero point error	ask the factory to reset the encoder zero
		motor U、 V、 W lead connect wrong	confirm the wiring sequence
AL-2	main circuit overvoltage	input L1 L2 L3 power voltage higher than AC260V	reduce power voltage
		brake circuit capacity is not enough (Usually occur in the occasion that frequently and rapidly start and stop and the load inertia is large)	1.prolong control system acceleration and deceleration time 2.contact manufacturer to increase braking resistance capacity
AL-3	main circuit undervoltage	input L1 L2 L3 power voltage less than AC170V	find out the external reason of low voltage
		servo protection action	replace a new servo drive
AL-4	position error	operation, the motor does not turn any angle, immediately alarm	1.confirm UVW wire phase sequence correct or not 2.confirm if the input pulse frequency is too high 3.pulse electronics gear setting it too large, set parameter Pn9 Pn10 correctly
		alarm when rotating (input pulse abnormal)	confirm input pulse frequency and width
		alarm when rotating (error detection range is too small)	set parameter Pn13 larger

Chapter 7 Alarm and disposal

		alarm when rotating (position proportion gain is too small)	increase position gain Pn5 set value
		alarm when rotating (lack of torque)	higher power servo motor
AL-6	speed amplifier saturation	motor mechanically locked	check the load mechanical part
		the load is too large	1.decrease load, 2.change a higher power drive and motor
AL-9	encoder failure	encoder wiring wrong or line break	check or change encoder wire
		caused by interference	set Pn58 to 1
		the encoder cable is too long, lead to the encoder power voltage a little low	shorten the cable
AL-11	Over-current 1	grounding defective	grounding correctly
		motor insulation damaged	replace a new motor
		motor winding with short circuit	replace a new motor
		servo motor parameters do not match	Correctly set motor ID number Pn1
		deceleration time is too short	increase the upper computer acceleration and deceleration time
		current surge	1.decrease parameter Pn43 Pn5 value 2.increase parameter Pn64 value
		input pulse is not well-distributed	increase pulse smoothing parameter Pn15 value
		servo protection action	replace a new servo drive
AL-12	Over-current 2	motor insulation damaged	replace a new motor
		grounding defective	grounding correctly
		servo protection action	Replace a new servo drive

Chapter 7 Alarm and disposal

AL-13	excess load	servo output torque over the allowed value	1.mechanically locked or resistance is large, 2.motor type is not good, change to higher power drive and motor
AL-14	braking abnormal	servo protection action	Increase the external braking unit
		brake circuit capacity is not enough	1.increase acceleration/deceleration time constant 2.replace a larger power servo and motor
		main circuit power is too high	check the AC input power supply
AL-15	encoder count abnormal	Encoder wiring error	check or replace the motor encoder wire
		grounding defective	grounding correctly
		servo motor defective	replace servo motor
AL-16	motor thermal overload	motor over load long time	replace servo drive
AL-20	EEPROM abnormal	servo inside EEPROM read-write abnormal	replace servo drive
AL-24	FPGA error	FPGA communication error	replace servo drive
AL-32	encoder UVW abnormal	Encoder cable or encoder damage	replace servo drive
AL-45	ADC error	ADC error	replace servo drive
AL-46	servo power sign abnormal	servo power sign abnormal	replace servo drive

Special explanation: if the servo drive alarm, but after power on again, the alarm will disappear. Generally, it is considered that the servo drive outside parts with problem or the parameter adjusted improperly; please check the servo peripheral

Chapter 7 Alarm and disposal

parts. For example: power voltage, controller, mechanical load, motor etc. if the peripheral parts without problem, please consult the manufacture about parameter adjustment.

If the alarm cannot clear after power on, please replace the servo drive and observe.

7.3 FAQ or exception handling in use

1、 No-load operation motor vibrate strongly or scream, load with noise or position error.

Handling method: confirm the servo drive PN 1 parameter whether match with the connected motor, set correct parameter based on table 7.2, then restore to factory value.

For example:

1) check table appendix A, and get the motor ID=1

2) operate drive, set PN0 to 0

3) set PN1 to motor ID number, that is PN1=1

4) operate drive and enter SN-DEF interface, press the ENTER key on the display panel for 2 seconds, when display DONE, indicates success.

5) turn off and power on again, done.

2、 The motor run positional accuracy and the required accuracy deviation is very large but regular

Handling method: Set position pulse electronic gear ratio correctly.

This servo system default 10000 pulses rotate a circle. If the upper computer requires 3000 pulses for motor to rotate a circle, need to set gear ratio to meet requirement.

It can be calculated by below format:

$$3000 * (PN9 / PN10) = 10000$$

$$\text{Get } PN9=10 \quad PN10=3$$

3、 drive input, output signal level reversed

1) Set parameter PN53 PN54 PN55 to set input/output suitable high level or low level so as to adapt to different input/output level requirement of the controller.

4、 upper computer pulse but motor not running

Make sure PN4=0, check UN-12 monitoring value, if there is digital shows that means the drive received pulse, it indicates the control signal connection without problem. Please refer to method 1 to clear fault. If display F 0.0 it indicates the drive do not received pulse. Please refer to method 2 to clear fault .UN-12 display unit is KHZ , like display F150, it indicates the present drive received pulse frequency is 150KHZ.

Method1:

Set below two parameters: PN95=1 PN4=3 in F2 model performs JOG function. If the motor can rotate, it indicates the motor, the motor power line, encoder wire connected correct, there is no problem.

Check CN1 signal if with INH signal or CLE signal with ON or not. It can be found by check UN-16.

If the motor can not run, please do following inspection

1) Check the drive with enable motor or not, and turn the motor shaft by hand. If it can not be rotated, indicates the motor enable locked. If it can be rotated, indicates there is no enable, please check if CN1 input enable signal correct connected or not. If the enable signal do not need to control by the upper

Chapter 7 Alarm and disposal

computer. CN1 input enable signal not connected, can set PN95=1, drive motor automatically enable locked.

- 2) Check if the power cable which between drive and motor connected correctly or not, and the socket loose or not. Drive output terminal U V W PE and motor U V W PE whether corresponding. Power cable U V W PE must be connected correctly, can not change the sequence randomly.
- 3) Please contact the factory technical personnel.

Method 2:

- 1) Check the pulse amplitude input to drive, the standard is 5V. If the pulse amplitude is 12V, must series 1K resistance; if the pulse amplitude is 24K, must series 2K resistance. The drive input circuit will be burned if not series resistance according to the requirements. Lead to the servo can not receive pulse.
- 2) Confirm the pulse connection mode is correct, the connection mode: differential connection mode and single end connection mode. Specific see below chart

Chapter 7 Alarm and disposal

Typic application: numerical control system, motion

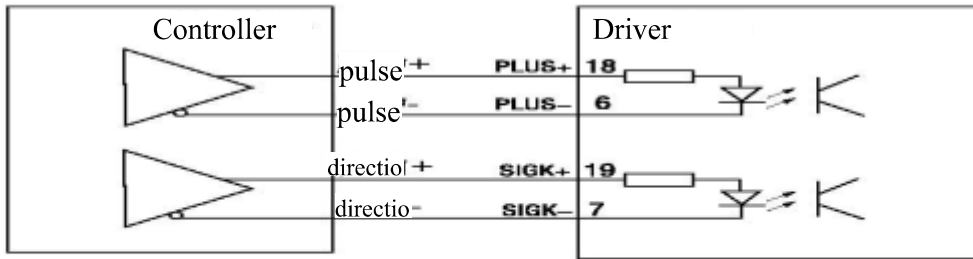

Typic application: PLC, SCM controller

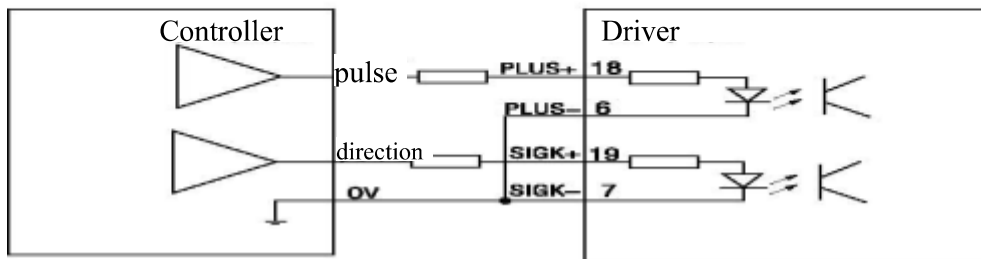
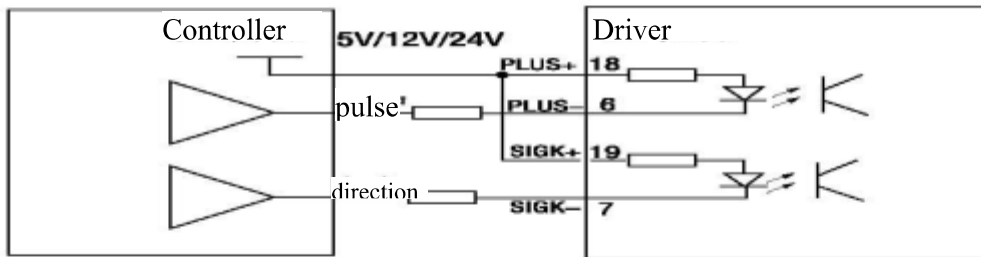

5、 The motor can only turn to one direction

- 1) Confirm the input pulse type to drive, pulse and direction setting PN8=0; Double pulse setting PN8=1; A/B orthogonal pulse setting PN8=1, and confirm the drive model is SDxxx-D。
- 2) Observe UN-12 display state, upper computer send forward signal should display F xx. Reversal signal should display F - xx. If the upper computer send forward signal or reversal signal both display F xx or F - xx. Please check the direction signal SIGN from upper computer to drive.
- 3) Please contact the factory technical personnel.

Chapter 7 Alarm and disposal

6、 high speed stop or from top to down does negative work, the drive display AL—3

- 1) modify the upper computer deceleration time
- 2) reduce motor speed
- 3) small power drive access external braking resistance
- 4) medium high power drive please contact the factory technical personnel.

7、 there is no display when power on

- 1) Confirm power connecting wire and input power
- 2) Please contact the factory technical personnel.

8、 Power on drive display “。 。 。 。 。 。 。 ” or “888888”

- 1) the input power lack phase, check each phase power line
- 2) servo drive damaged by short circuit, and lead to servo drive damaged. The motor damage can be judged by rotate motor shaft under the no-load situation, rotate a circle, if the shaft is not smooth, can be concluded that the motor is damaged.

9、 Motor position is not accurate

- 1) Irregular, check motor connection mechanical part
- 2) Regular, monitor and analyse UN-02 UN-03 UN-04 UN-05 can get results
- 3) Screening interference, the signal wire use shield wire and grounding, add magnetic coiling. Motor cable change to shield wire. Electronic control system wiring again, make the strong and weak electricity line separately. Install filter etc.

The effect of the servo monitoring menu in analysis and adjustment processes.

- 1) UN-01 motor speed observe the motor actual speed
- 2) UN-02 UN-03 The current position of the motor: used to observe the current position of the motor. It is represented by the number of pulses. For example, if the control takes a fixed trajectory, the displayed value should be the same when each

Chapter 7 Alarm and disposal

repeat operation is performed. Indicates accurate positioning each time.

- 3) UN-04 UN-05 Pulse command count, used to monitor whether the pulse from the host computer is accurate. For example, if the control traverses a fixed trajectory, the displayed value should be the same when it comes to the same position each time it repeats its operation, indicating that the pulse sent by the host computer is accurate.
- 4) UN-08 motor present torque, used to observe motor actual operate situation. If this value over 90 for a long time, means the current motor type is small.
- 5) UN-12 input pulse frequency, used to observe pulse frequency from upper computer and stability state
- 6) UN-17 input signal state, used to judge whether the input signal is normal
- 7) UN-18 output signal state, used to judge whether the output signal is normal
- 8) UN-23 input model voltage AD value, used to indicate the level of the input voltage, it's 2048 with no input.

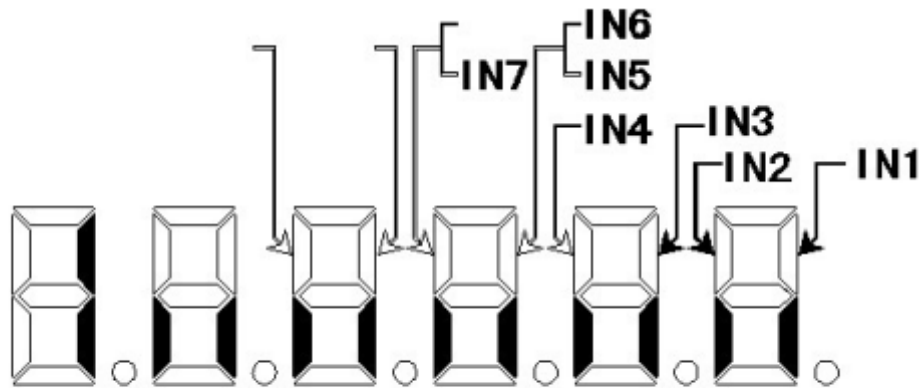

Input terminal display

Light display ON, go out display OFF

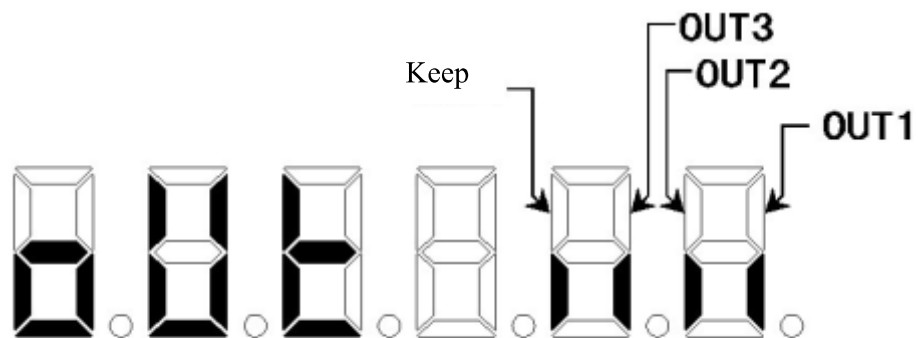

Output terminal display

Light display ON, go out display OFF