

BH-SD Series(Ethercat) AC Servo Driver Manual



BH-80SM-ECAT-0.4KW

Thank you for choosing SDC series servo driver. Please read this manual before using. The main contents of this manual include:

- * Servo driver inspection, installation and wiring steps.
- * Digital panel operation steps, status display, trouble alarm and disposal.
- * Servo system control mode, trial running and adjustment steps.
- * List of all the parameters of the servo drives.
- * Servo drives specifications.

For daily inspection, maintenance, finding the exception reasons and countermeasures, please keep this manual for easy reference.

Note: Please give this manual to the end user so as to maximize the utility of the servo drives.

- The manual contents may be changed due to the product improvements, there will be no prior notice.
- Any changes made to the product by users, the company will not undertake any responsibility and the product warranty will be invalid.

When reading this manual, please pay special attention to the following warning signs



Indicates the wrong operation may cause disastrous consequences—death or serious injury!



Indicates the wrong operation may hurt the operator and also make damage to the equipment!



Indicates improper use may damage the product and equipment!

Contents

Chapter 1 Product Model and Installation.....	3
1.1 Product model and installation dimensions.....	3
1.2 Servo drive and motor specifications.....	7
1.3 Servo drive installation.....	8
Chapter 2 Servo drives and motor wiring	
2.1 Wiring of servo drive power supplies and peripherals	10
2.2 Electrical connection of the terminals	13
2.3 Signal interface schematic	18
Chapter 3 Operation and display	
3.1 Keyboard operation.....	20
3.2 Monitoring methods	22
3.3 Parameter setting.....	23
3.4 Parameter management	24
3.5 F2 operating mode (jogging test function)	27
3.6 Others	28
Chapter 4 Parameters	
4.1.0 Full parameter list.....	29
4.1.1 Detailed list of the functional significance of each parameter	31
4.2 Parametric commissioning block diagram model	40
4.3 Description of key servo parameters	40
4.4 Steps for debugging parameters in practice.....	41
Chapter 5 Operation and Commissioning	
5.1 Special notes on commissioning:	42
5.2 Position-controlled operation	42
5.3 jog operation.....	43
Chapter 6 RS485 communication	
6.1 RS485 communication hardware interface	44
6.2 Communication protocols	45
6.3 Handling of communication error messages and data:	50

Chapter 1 Product inspection and installation

6.4 Examples of communication commands.....	51
Chapter 7 EtherCAT Communication Functions	
7.1 EtherCAT Communication Basics.....	54
7.1.1 EtherCAT communication.....	54
7.1.2 EtherCAT State Machine.....	54
7.2 Communication contemporaneous mode	56
7.3 Drive mode.....	59
7.3.1 Servo state machines	59
7.3.2 Control words 6040h.....	61
7.3.3 Status word 6041h.....	62
7.3.4 Operating mode setting 6060h.....	63
7.3.5 Current operating mode display 6061h	64
7.3.6 List of various servo states	64
7.3.7 Various modes of servo operation	65
7.3.8 Probe function.....	68
7.3.9 Parameter transfer function	82
Chapter 8 Alarm and Handling	
8.1 Alarm List.....	83
8.2 Alarm handling.....	85

DIMENSIONS AND TECHNICAL DETAILS.

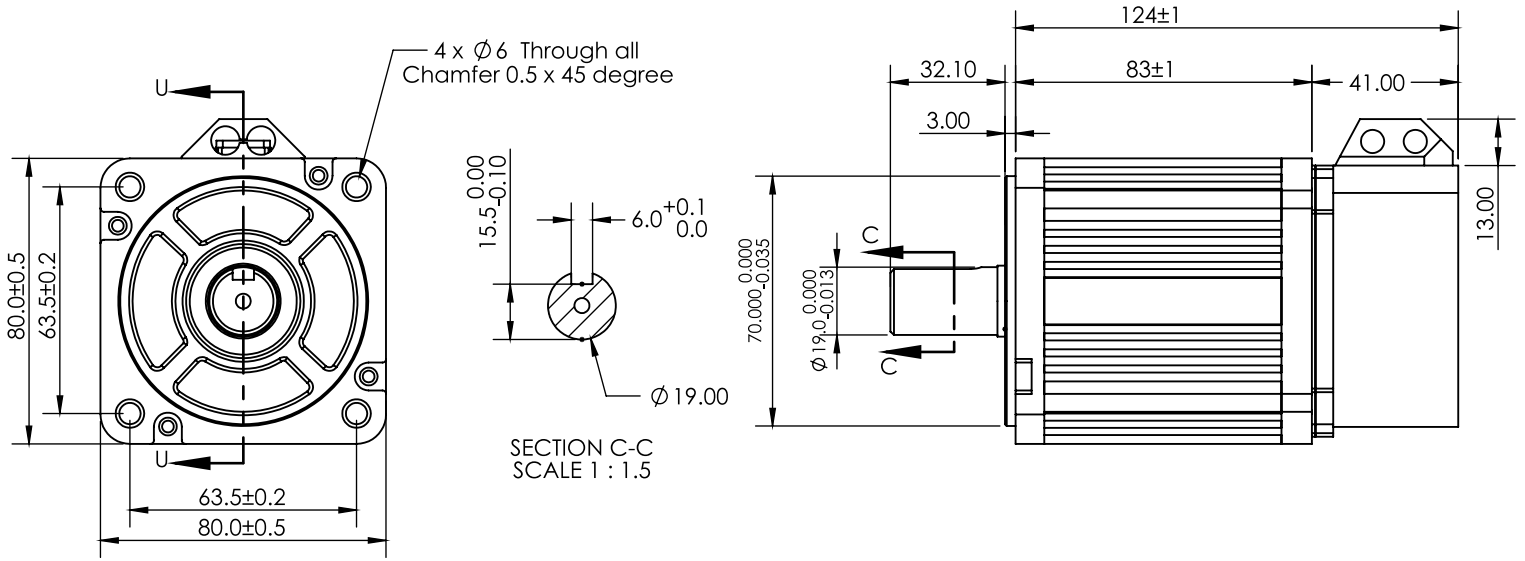

MOTOR MODEL	BH-80SM-400W
Rated Power (KW)	400
Rated Voltage (V)	230
Rated Current (A)	2
Peak Current (A)	6
Rated Speed (RPM)	3000
Rated Torque (Nm)	1.27
Peak Torque (N.M)	3.8
Back emf(v/1000r/min)	40
Torque Coefficient (Nm/A)	0.64
Rotor Inertia (Kg.MP)	1.05X10 ⁻⁴
Winding Resistance (Ω)	4.44
Winding Inductance (mH)	7.93
Electrical Time Constant(ms)	1.66
Weight (KG)	1.78
No of Encoder Lines (PPR)	2500
Insulation Class	Class F(130 ⁰ c)
Safety Class	IP 65

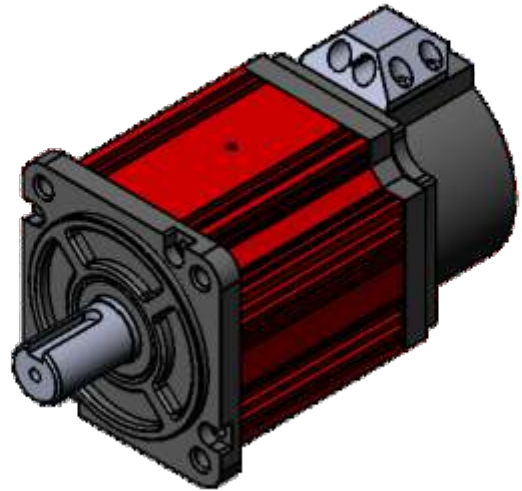

Motor Options Available -
 Standard Model - BH-80SM-ECAT-0.4KW
 With Low Backlash Planetary Gearbox - **PL**
 With Electro Magnetic Brake - **BRK**
 With Helical Gearbox - **HL**
 CE Certificate - N - STANDARD/CE - CERTIFIED
ORDERING CODE - BH-80SM-ECAT-0.4KW

Temperature; -20⁰c to +40⁰c, humidity; relative humidity < 90%

Chapter 1 Product Model and Installation

Overview

SDC series servo is the sixth generation of our bus type servo, which supports EtherCAT bus communication protocol and industrial fieldbus interface; it greatly reduces the complicated electrical wiring connection and makes it simple for users to use.

1.1 Product model and installation size

The servo products have been completely tested before leaving the factory, in order to prevent the products from being delivered in a negligent manner, please check the following matters in detail after unpacking.

1) Check that the servo driver and motor model are the same as the model ordered. 2) Check the appearance of the servo driver and motor for damage and scratches. If any of the above items show signs of malfunction or abnormality, contact your local distributor immediately.

1.1.1 Model confirmation



SDC Series: EtherCAT bus communication protocol

1.1.2 BH-SD-Ethercat Servo Drive with standard accessories

- ① CN1 plug (DB15 hole) 1 set
- ② CN2 plug (DB9 pin) 1 set
- ③ 5 position power plug 1 pc
- ④ 3 position power plug 1 pc
- ⑤ CN3 CN4 high-speed network communication cable 2 pcs

1.1.3 Servo Drive Mounting Dimensions

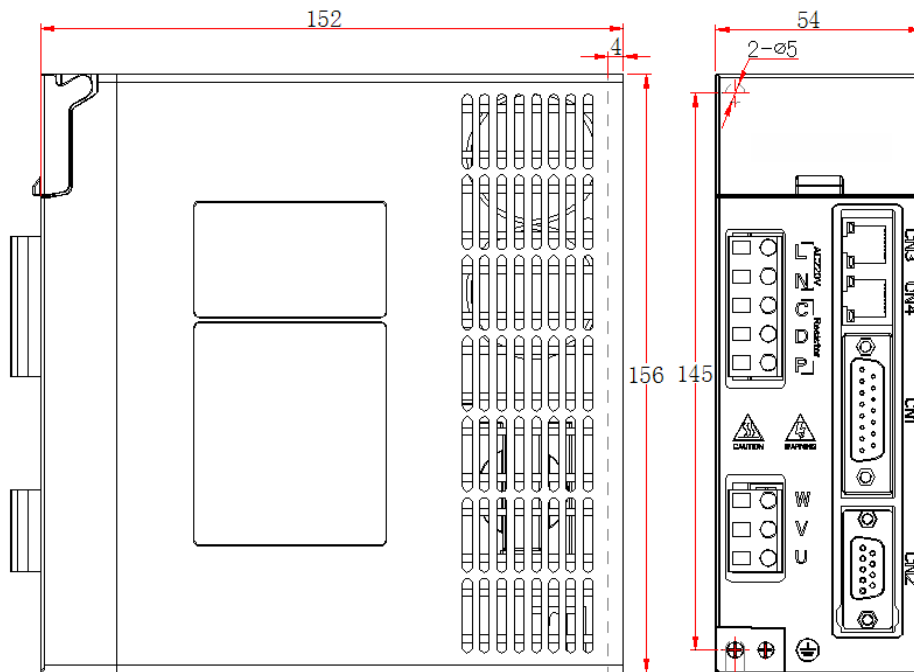

servo drive installation size drawing

Note: L, N for the 220V power input terminals, P, D, C for the external brake resistor terminals must not be connected wrong!

Chapter 1 Product inspection and installation

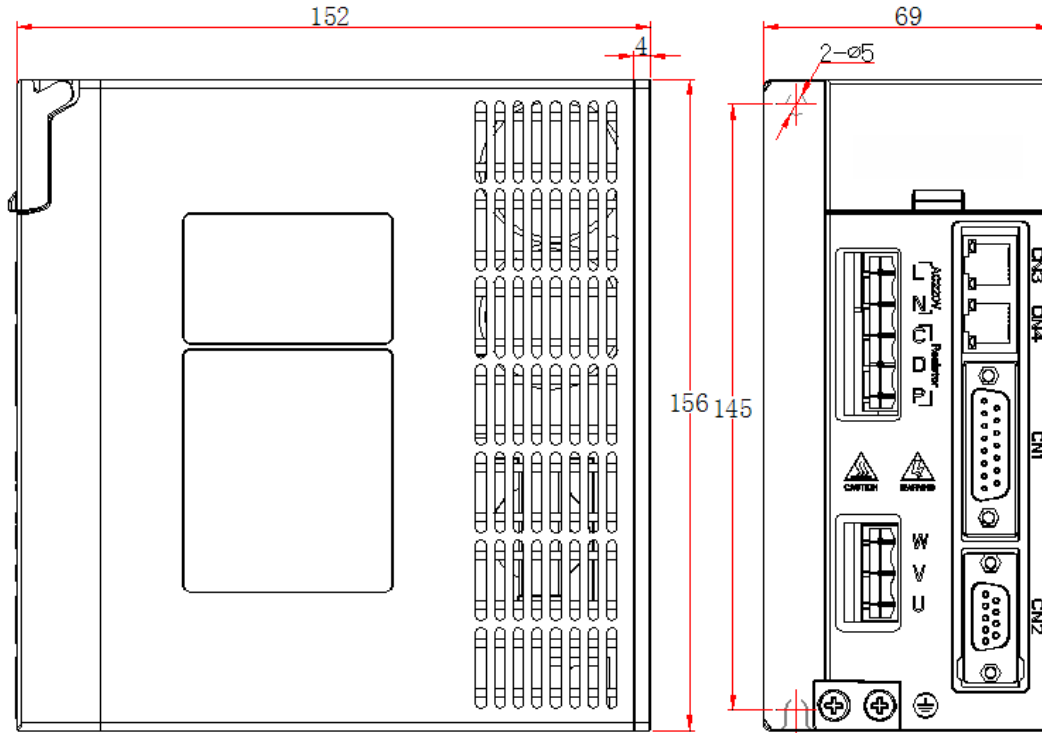

servo drive installation size drawing

Note: L, N for the 220V power input terminals, P, D, C for the external brake resistor terminals must not be connected wrong!

Chapter 1 Product inspection and installation

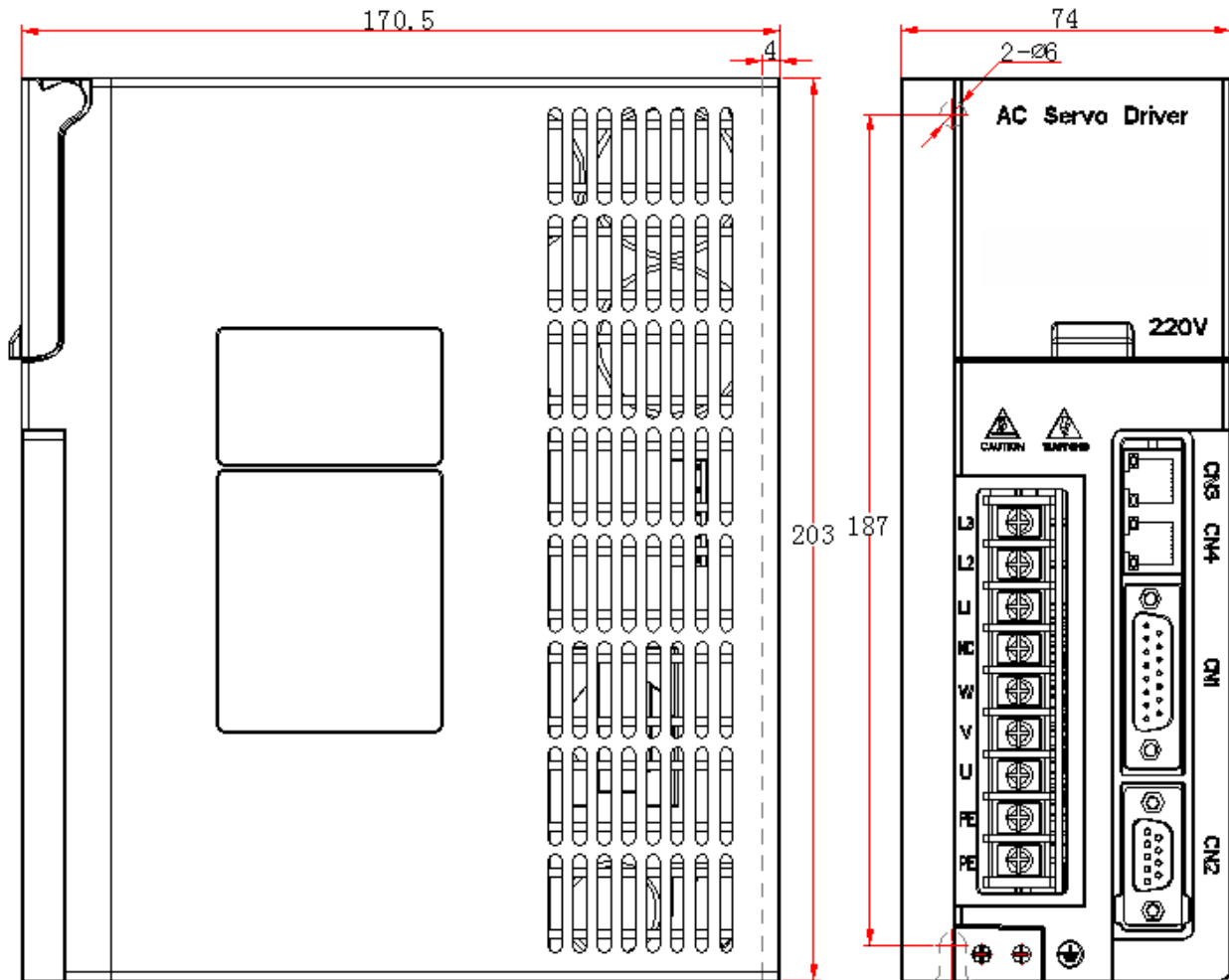

servo drive installation size drawing

1.2 Servo Drive and Motor Specifications

1.2.1 Servo Drive Specifications

Basic Specification	Model		BH-SD-ECAT
	Max current(A)		18.0
	Input power		Single-phase AC170~253V Three-phaseAC360V~440V
			50/60Hz
	Cooling method	Natural cooling	Air-cooling
	Control Mode		SVPWM Control
	Encoder		17 Bit or 23 Bit absolute single or multi-turn magnetic or optical encoders
Internal Function	Display and Operation		Six-digit, seven-segment display LED: four function operation keys.
	Control Mode		Position control / speed control / torque control / jogging operation / / EtherCAT bus communication
	Braking function		Built-in
	Protection function		Undervoltage, overvoltage, overload, overcurrent, abnormal encoder, braking, position overrun, etc.
Position control mode	Command control mode		EtherCAT bus communication
	Speed control range		Speed Ratio: 1:5000
	Rate of speed change		Speed fluctuation rate: $< \pm 0.03$ (load 0~100%) . $< \pm 0.05$ (Power supply -15%~+10%) .
	Command smoothing method		Linear time constant 1 ms~10000ms (0r/min \longleftrightarrow 1000r/min)
	Frequency characteristics		300HZ
Input/output signal	Position signal output	Output Type	EtherCAT bus communication
	Input Signal	3-point opto-isolated input	Function Reservation
	Output Signal	2-point open collector	Function Reservation
Operating temperature			Work:0°C~55°C, Storage:-20°C~80°C.

1.3 Servo Drive Installation

1.3.1 Installation environmental conditions

The environment in which the servo drive is installed has a direct impact on the normal function of the drive and its service life, so the installation environment of the drive must meet the following conditions.

Items	BH-SD-Ecat Servo Drives
Operating temperature/humidity	0°C~55°C (No Frost) ; Below 90%RH (no condensation)
Storage temperature / humidity	-20°C~80°C; Below 90%RH (no condensation)
Atmosphere	No corrosive gases, flammable gases, oil mist or dust, etc. in the control cabinet.
Vibration	Less than 0.5G (4.9m/s ²) 10 Hz - 60 Hz (non-continuous operation).
Protection level	IP54

When installing several drives in the control cabinet, please pay attention to the placement to keep enough space to obtain sufficient heat dissipation; please also provide additional cooling fans to keep the peripheral temperature of the servo drive below 55 °C.

When installing, please stand the drive vertically, with the front side facing forward and the top side facing upward to facilitate heat dissipation.

When assembling, be careful to avoid drilling chips and other foreign objects falling into the drive.

Please use M4 screws for installation.

If there is a vibration source nearby (punching machine), please use vibration absorber or install anti-vibration rubber gasket if it cannot be avoided.

When there are large magnetic switches, fusion machines and other noise interference sources near the drive, the drive will be easily disturbed by the outside world and cause wrong operation, so it is necessary to install a noise filter; however, the noise filter will increase the leakage current, so it is necessary to install an insulating transformer at the input of the drive.

1.3.2 Servo mounting direction and spacing

The following diagram shows the installation interval between single and multiple drive units. The actual installation should leave as large an interval as possible to ensure good heat dissipation conditions.

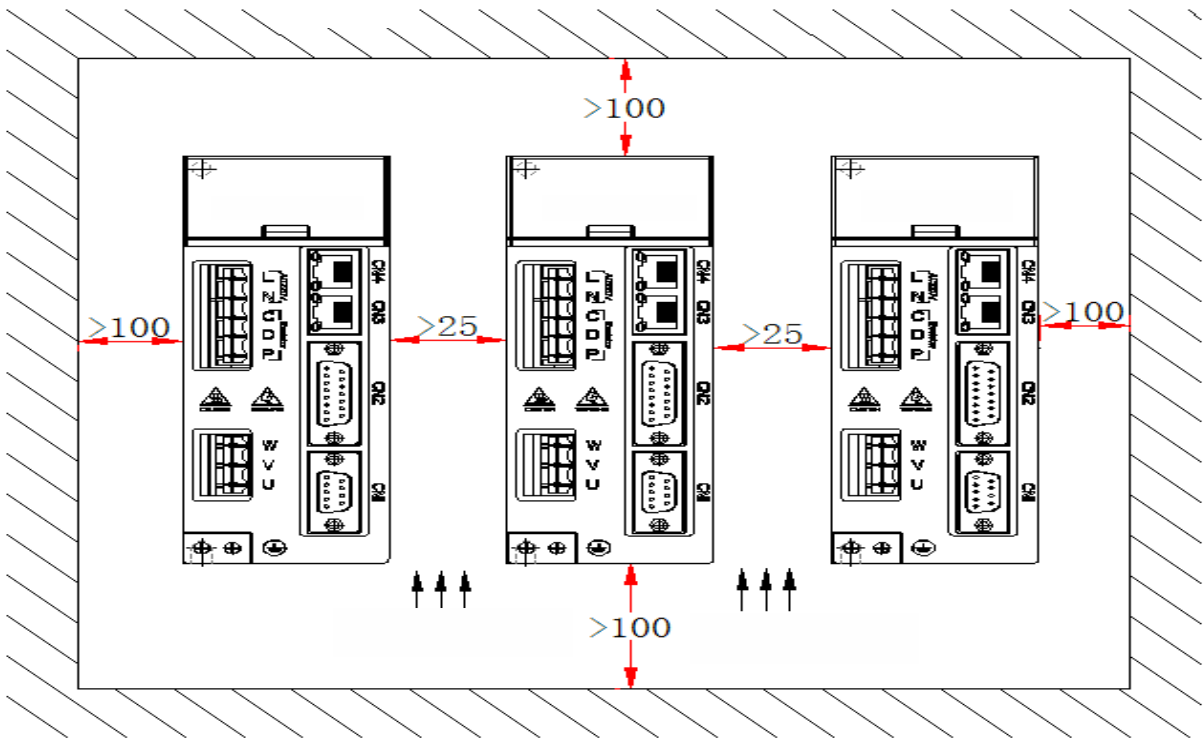
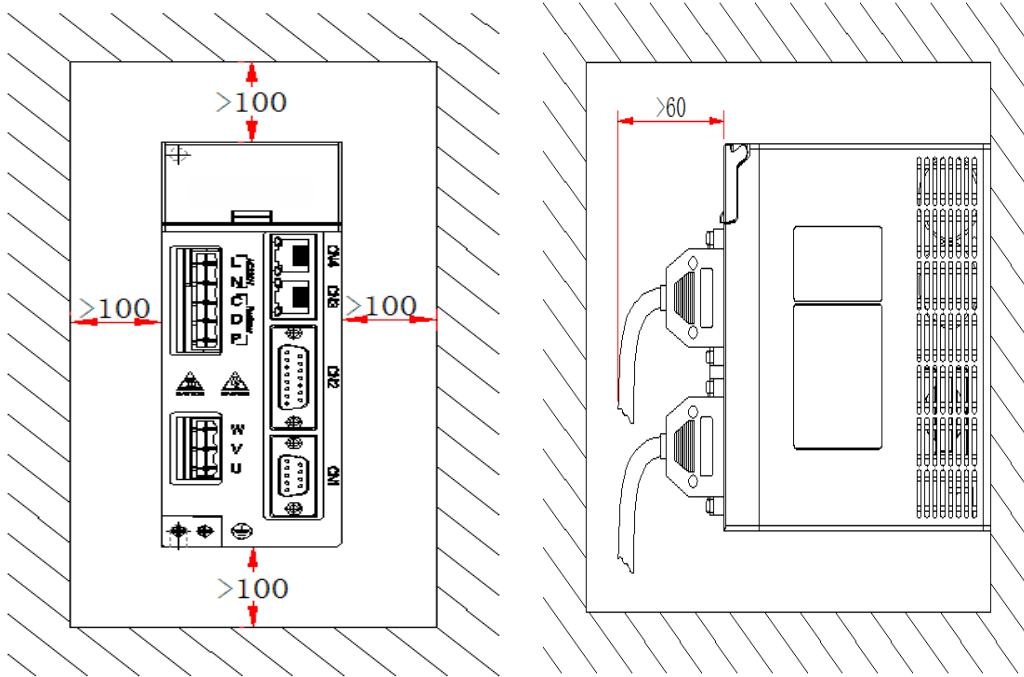

Chapter 2 Servo drives and motor wiring

2.1 Servo driver power supply and peripheral device wiring

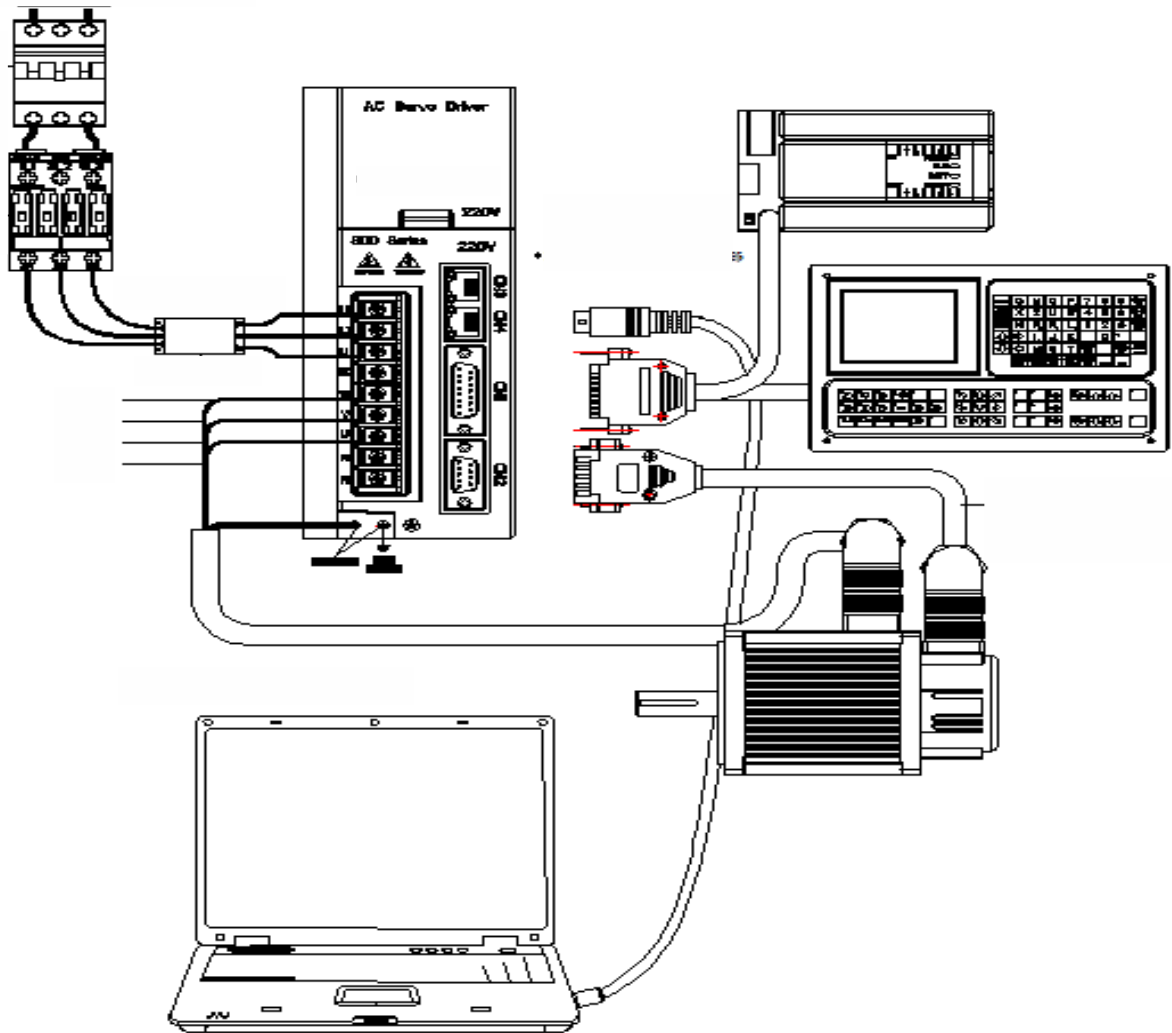

SDC04 servo driver peripheral device wiring

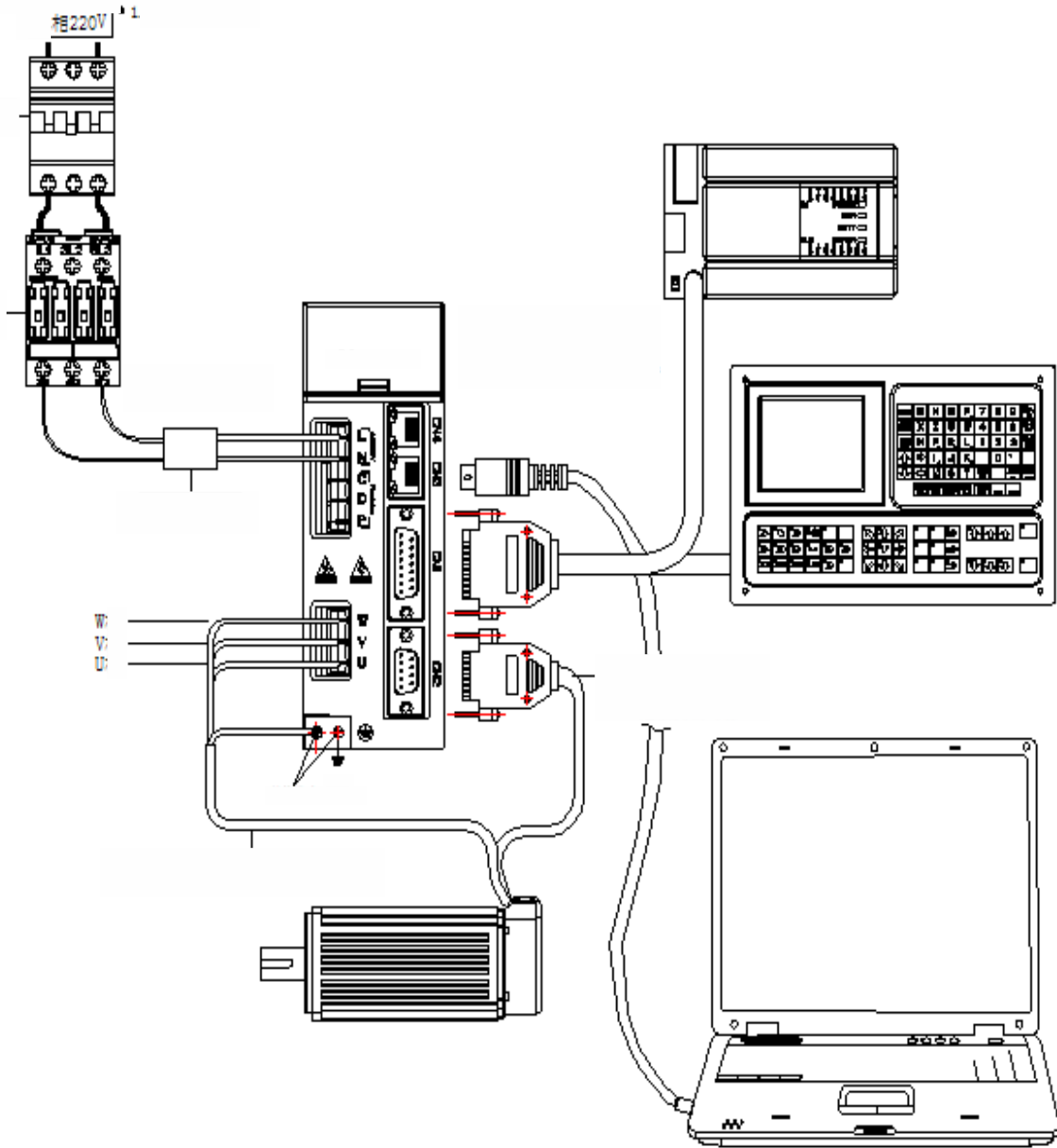

SDC20 servo driver peripheral device wiring

2.1.1 Example of standard wiring diagram

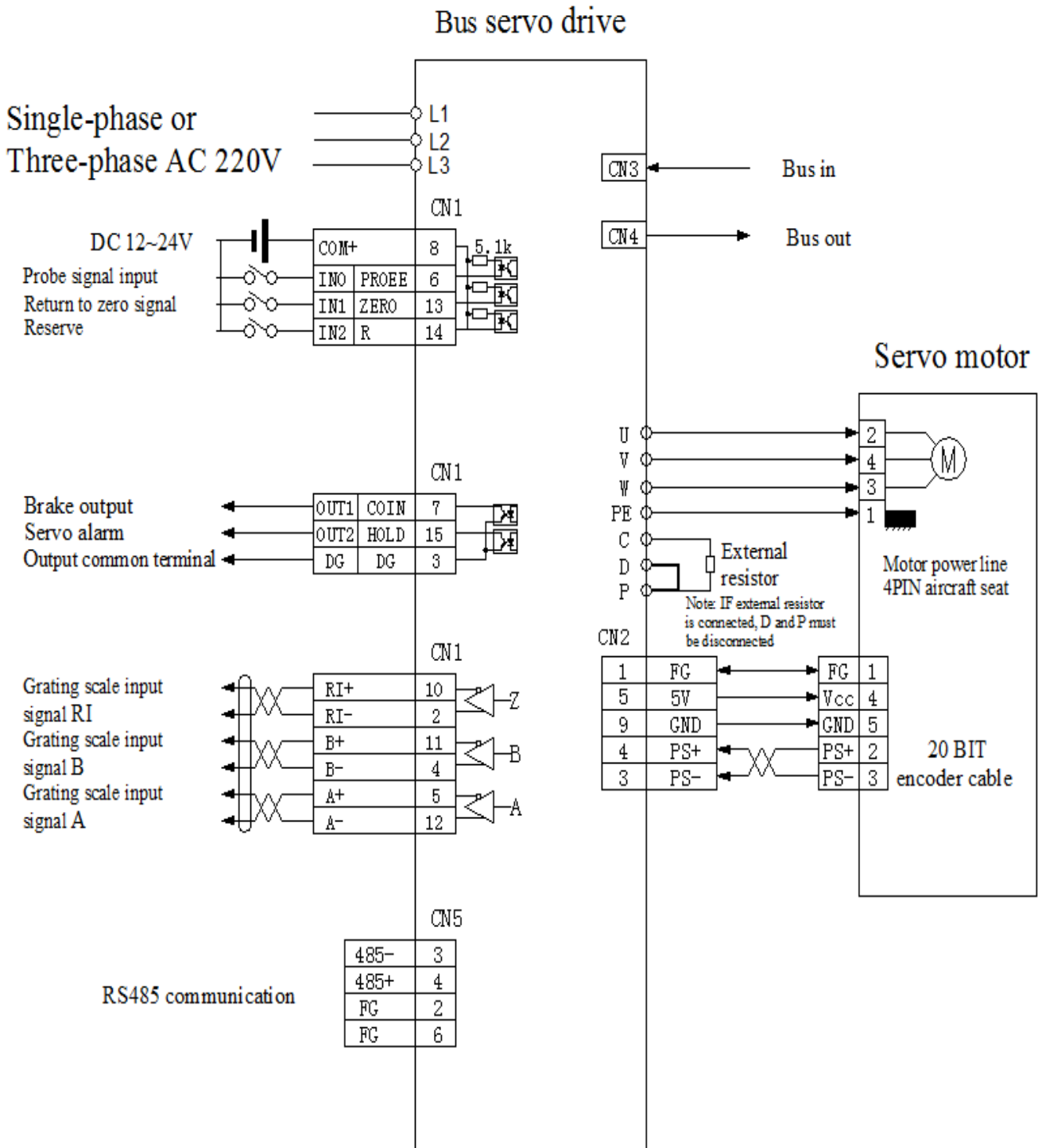

SDC04 Example of control mode wiring diagram

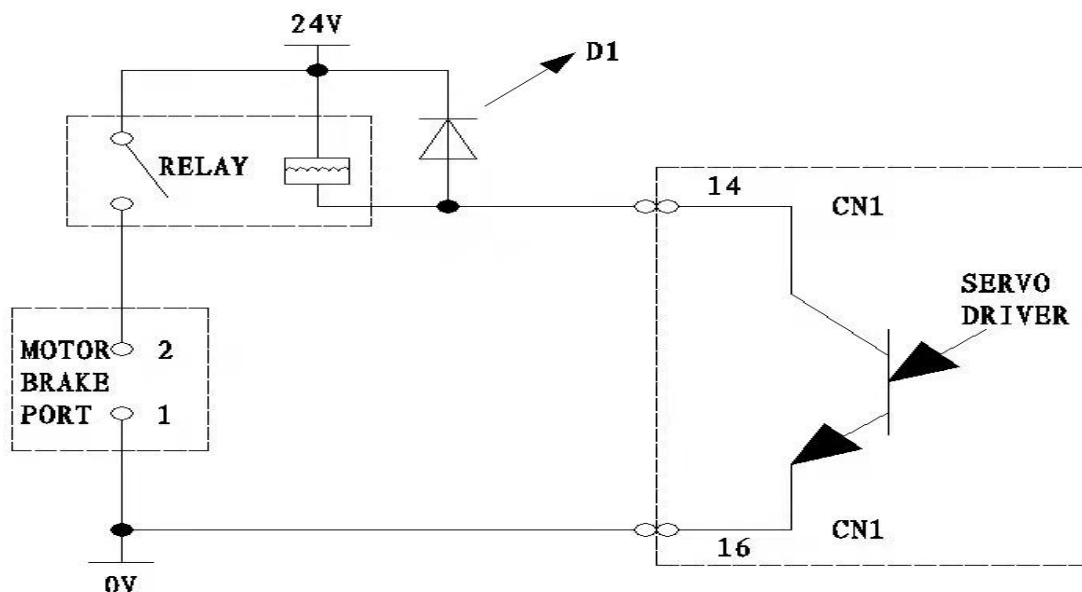

Wiring diagram of brake motor with brake

2.2 Electrical connection of the terminals

2.2.1 Power terminal definition

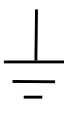
	Terminal Marking	Signal Definition	Function
	L	Main circuit power single-phase	Main circuit power input terminal ~220V 50Hz. Note: Do not connect with the motor output terminals U, V, W.
	N		
	P	External braking resistor selection terminal	With built-in braking resistor: P and D short-circuited connection
	D		With external braking resistor: P and D open circuit, external resistor connected between P and C
	C		
		System grounding	1, Grounding resistance of grounding terminal <math>< 100\Omega</math>; 2, The servo motor output and power input are grounded at a common point.
	W	Servo motor output	The servo motor output terminals must be connected to the motor W, V and U
	V		

	U		terminals correspondingly.
--	---	--	----------------------------

2.2.2 Power terminal definition

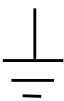
	Terminal	Signal Definition	Function
	L1	Main circuit power Single-phase or three-phase	Main circuit power input terminal ~220V 50Hz, single phase connected to L1 L2. Note: Do not connect with the motor output terminals U, V, W.
	L2		
	L3		
	PE Or 	System grounding	1, Grounding resistance of grounding terminal < 100Ω; 2, The servo motor output and power input are grounded at a common point.
	U	Servo motor output	The servo motor output terminals must be connected to the motor W, V and U terminals correspondingly.
	V		
	W		
	P	External braking resistor selection terminal	With built-in braking resistor: P and D short-circuited connection
	D		With external braking resistor: P and D open circuit, external resistor connected between P and C
	C		

2.2.3 Wiring of power line terminals

- L1, L2, L3, PE, U, V, W terminals, line cross-sectional area $\geq 1.5 \text{ mm}^2$ (AWG14-16). L, N terminals, line cross-sectional area $\geq 1.0 \text{ mm}^2$ (AWG16-18).
- Grounding: The grounding wire should be as thick as possible, and the driver and servo motor should be grounded at one point in the PE terminal with a grounding resistance of <100Ω.
- It is recommended that power be supplied by a three-phase isolation transformer to reduce the possibility of electric shock injuries.
- recommends that the power supply be supplied with electricity via a noise filter to improve immunity to interference. Please install a non-fused type (NFB) circuit breaker so that the external power can be disconnected in time in case of drive failure.

2.2.4 Signal Terminal Definition

SDC servo drive unit interface terminal configuration is as follows: CN1 signal control terminal is DB15 connector, socket is pin type, plug is hole type; CN2 feedback terminal is DB9 connector, socket is two rows of 9-core hole type, plug is two rows of 9-core pin type.

1) Control terminals CN1

Abbreviation of control method:

Terminal No.	Signal Name	Marking	I/O	System default functions
CN1-8	The positive terminal of the power supply of Input terminal	COM+	Power supply	The positive power supply of the input terminal is used to drive the input terminal's opto-coupler DC12 to 24V with a current of $\geq 100\text{mA}$.
CN1-6	Input port 0	IN0	input	Probe 1 input/home switch
CN1-13	Input port 1	IN1	input	Probe 2 input/negative limit switch
CN1-14	Input port 2	IN2	input	Probe 3 input/positive limit switch
CN1-7	Output port 1	OUT1	output	brake output
CN1-15	Output port 2	OUT2	output	Alarm output
CN1-3	Common side of output terminal	DG	Common side	The common terminal of the control signal output terminal.
CN1-5	Signal input reserved		input	Function Reserved
CN1-12				
CN1-11			input	
CN1-4				
CN1-10			input	
CN1-2				

2) Code panel signal terminal CN2

Terminal No.	Signal Name	Marking	I/O	Functions
CN2-4	Serial encoder signals	PS+	Bidirectional	Serial data of code disk
CN2-3	Serial encoder signals	PS-	Bidirectional	Serial data of code disk
CN2-5	+5V Power supply	VCC		Power supply
CN2-9	Digital Ground	GND		Digital Ground
CN2-1	Shield Ground	FG		

3) Serial communication terminal CN5



Terminal No.	Signal Name	Marking	Functions
3	RS485 Communication Signal	485D-	RS485 Communication Signal
4	RS485 Communication Signal	485D+	RS485 Communication Signal

4) EtherCAT bus communication terminal CN3/CN4



This terminal is a standard RJ45 interface for EtherCAT bus communication, CN3 is the input, CN4 is the output, and the pins are defined as follows:

Pin No.	Signal Name	Signal Meaning
---------	-------------	----------------

1	TX+	Data sending +
2	TX-	Data sending -
3	RX+	Data reception +
4	-	-
5	-	-
6	RX-	Data reception -
7	-	-
8	-	-

2.2.5 Wiring of signal terminals

- Wire selection: shielded cable (the best choice of stranded shielded cable), core cross-sectional area $\geq 0.12\text{mm}^2$ (AWG24-26), the shielding layer shall be connected to the FG terminal.
- For the EtherCAT bus, use a shielded Super Category 6 cable and an RJ-45 plug with a metal shield.
- Cable length: cable length as short as possible, control CN1 cable not more than 3 meters, feedback signal CN2 cable length not more than 20 meters.
- Wiring: Wiring away from power lines to prevent interference cascading in. Please give the relevant line inductive components (coils) installed surge absorption elements; DC coil reverse parallel current-continuity diodes, AC coil parallel capacitive absorption circuit.

2.3 Signal interface schematic

2.3.1 Digital input interface circuit

The digital input interface circuit can be controlled by relay or open collector transistor circuit. The power supply is provided by the user, DC12-24V, current $\geq 100\text{mA}$; note; if the current polarity is reversed, it will make the servo driver not work. Input signals IN0-IN2 can all refer to this connection method

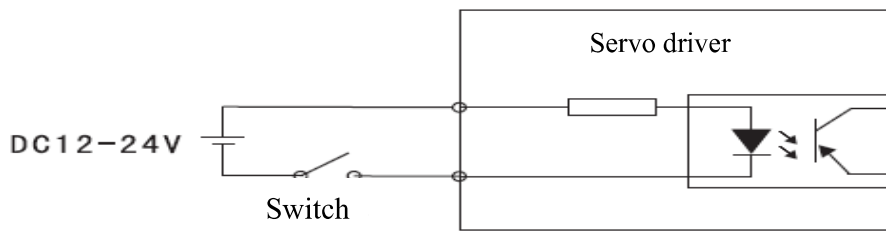

When the input signal is connected to 0V, the signal is ON input and valid. It can be judged by checking the display menu UN-17. When the input point is ON, the corresponding digital tube firm bar will light up. When the input is OFF, the corresponding digital tube vertical bar will be off. Reasonable application of this display makes it easy to debug and overhaul the servo's input signal.

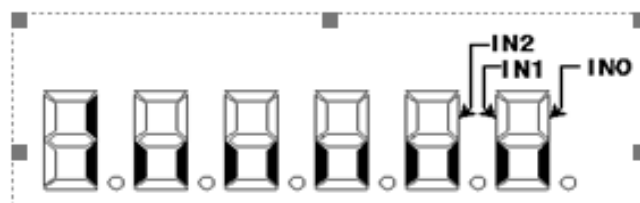

Input terminal display The strokes are lit to indicate ON, and extinguished to indicate OFF

2.3.2 Servo motor optical encoder input interface

For differential output method, AM26LS32, MC3487 or similar RS422 line driver is used as the receiver.

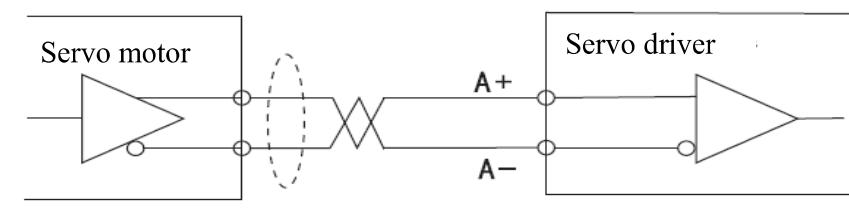

2.3.3 Digital output interface circuit

When using external power supply, please pay attention to the polarity of the power supply, the opposite polarity will lead to the destruction of the driver. The digital output is open collector, the maximum external voltage is 24V, and the maximum current is 10mA. in terms of load, when using inductive loads such as relays, a diode must be added in parallel with the inductive load, and if the diode is of opposite polarity, the driver will be destroyed. The status of the output signal can be observed by UN-18.

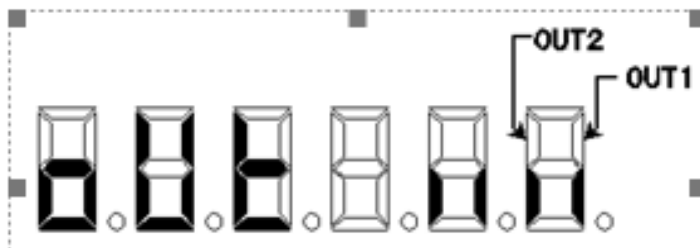
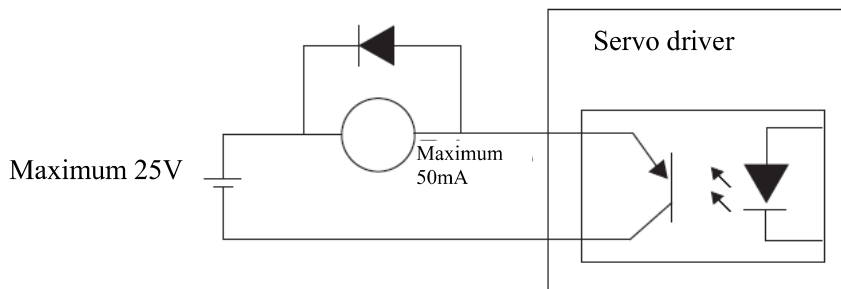

Input terminal display The strokes are lit to indicate ON, and extinguished to indicate OFF

Chapter 3 Operation and Display

3.1 Keyboard operation





The servo panel consists of 6 LED digital tube displays and 4 keys for displaying various status, setting parameters, etc. The key functions are as follows:

- ▲: Serial number, value increase, or option forward.
- ▼: The serial number, value is reduced, or the option is set back.
- ◀: Return to the previous level of the operation menu, or operation cancellation.
- ↵: Go to the next level of the operation menu, or enter a confirmation.



Note: ▲、▼ Hold pressed, the operation is repeated, and the longer the hold time, the faster the repetition rate.

*** The 6-digit LED digital tube displays various status and data of the system, and all digital tubes or the decimal point of the rightmost digital tube shows flashing, indicating the occurrence of an alarm.



*** The operation is executed according to multi-layer operation menu, the first layer is the main menu, including eight operation methods, and the second layer is the function menu under each operation method. The following figure shows the block diagram of the main menu operations.

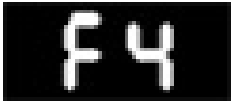

















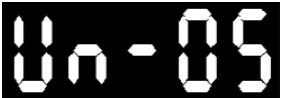

Display Status	Display Meaning
	Status Monitoring
	Parameters
	Parameter Operation
	Internal speed operation
	jog operation

Chapter 3 Operation and Display

	Code plate adjustment
	open loop operation

3.2 monitoring method

Select "Un-" in the first layer, and press the key  to enter the monitoring mode; there are 26 display states in total, and the user can use the , , keys to select the desired display mode.











Display Status	Display code	Display Meaning	Example
		Motor speed	The current motor speed is 500 rpm
		Current position lower 5 digits	
		Current position higher 5 digits	
		Instruction lower 5 digits	
		Instruction higher 5 digits	
		Position deviation lower 5 digits	
		Position deviation higher 5 digits	
		Percentage of rated torque of motor	
		Motor current *0.1A	
		Modbus Communication	

Chapter 3 Operation and Display

		error count	
		Control mode	
		Speed command	
		Torque command	
		Encoder single turn lower 5 digits	
		Encoder single turn higher 5 digits	
		Operation Status	
		Alarm Code	
		Encoder multiturn turns	
	C L-max	Max. peak current	Keep 2 s
		Show FPGA version	
		Encoder communication error count	

3.3 Parameter Setting

Select "PN-" in the first layer, and press the key to enter the parameter setting mode. Use 、 keys to select the parameter number, press key to display the value of the parameter, and use 、 keys to modify the



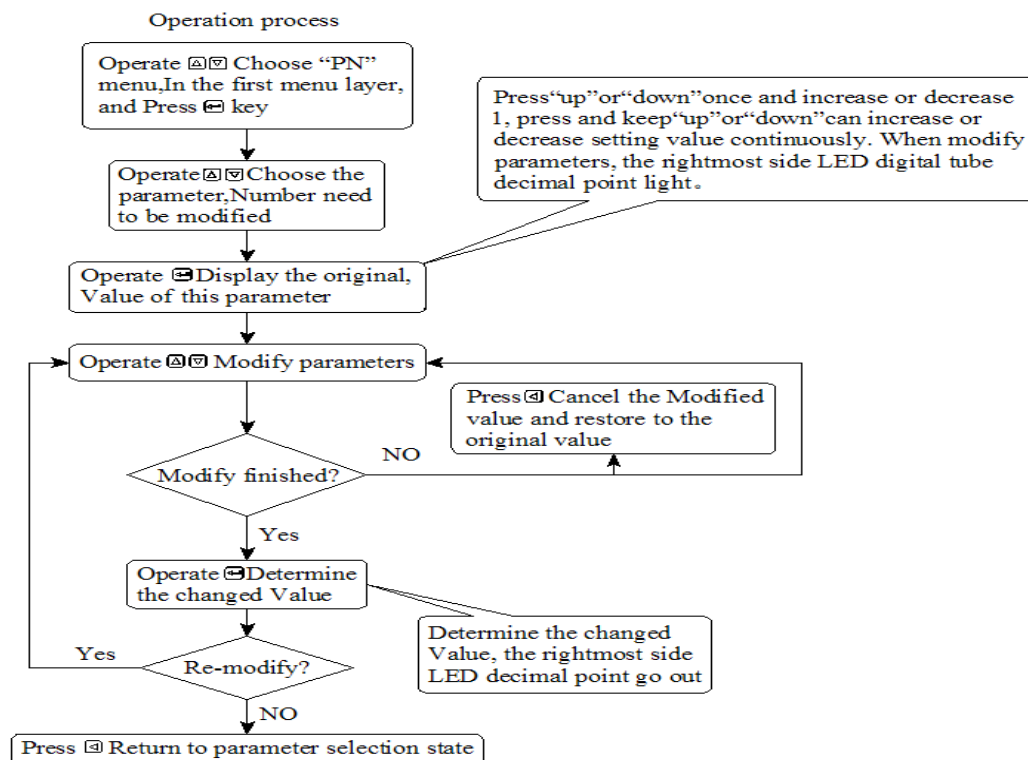

parameter value. Press the  or  key once, the parameter will increase or decrease by 1, and press and hold the  or  key, the parameter can be continuously increased or decreased. When the parameter value is modified, the decimal point of the LED digital tube on the far right is lit, press the key  to confirm that the modified value is valid, at this time the decimal point of the LED digital tube on the right is off, and the modified value will be reflected in the control immediately, after that press the  or  key to continue Modify the parameters, and press the key  to return to the parameter selection state after modification. If you are not satisfied with the value being modified, do not press the key  to confirm, you can press the key  to cancel, the parameter will restore the original value, and return to the parameter selection state.



The method of shifting to quickly set the data: go to the parameter value interface, press and hold the Enter key, and then press the Return key, the small dot in the lower right corner of the digital tube lights up, and press until the thousand or hundreds decimal place you want to modify lights up, indicating that it has been changed. Select this bit. Then press the up and

down keys to modify the value. After changing, press the Enter key to confirm. (V4000 and above are valid)

3.4 Parameter management

Parameter management mainly deals with the operation between memory and EEPROM, select "Sn-" in the first layer, and press  to enter the parameter management mode. First of all, you need to select the operation mode, there are 5 modes in total, use the , , keys to select. Take "parameter writing" as an example, select "Sn-Set", then press  and hold for more than 2 seconds, if the writing operation is successful, the display will display "DONE", if it fails, it will display "ERR". Then press the key  to return to the operation mode selection state.

Sn—SEt Parameter write means to write the parameters in the memory into the parameter area of EEPROM. If the user modifies the parameter, only the parameter value in the memory is changed, and the value will be restored to the original value next time the power is turned on. If you want to permanently change the parameter value, you need to perform a parameter write operation, and write the parameters in the memory into the parameter area of the EEPROM, and the modified parameters will be used after power-on.

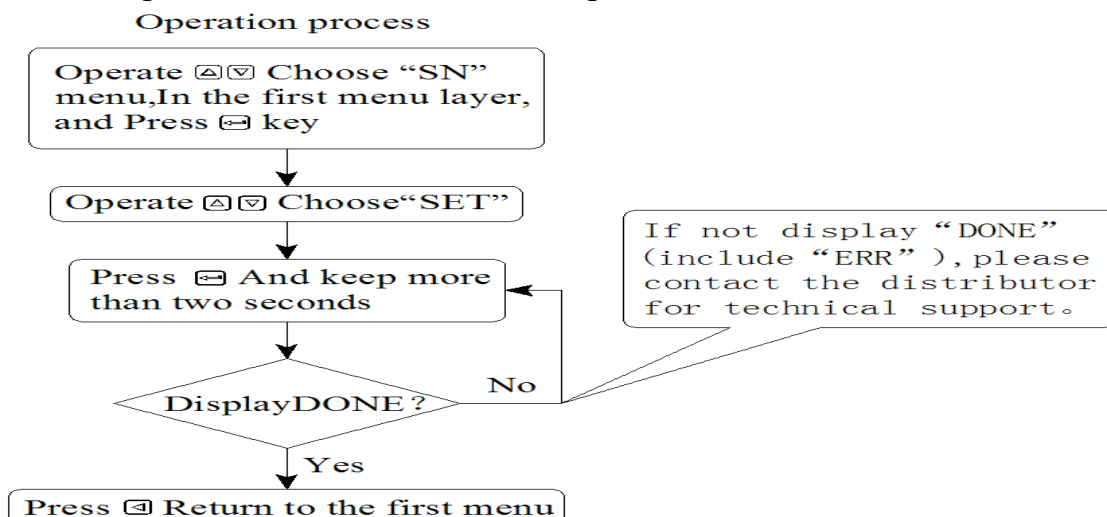

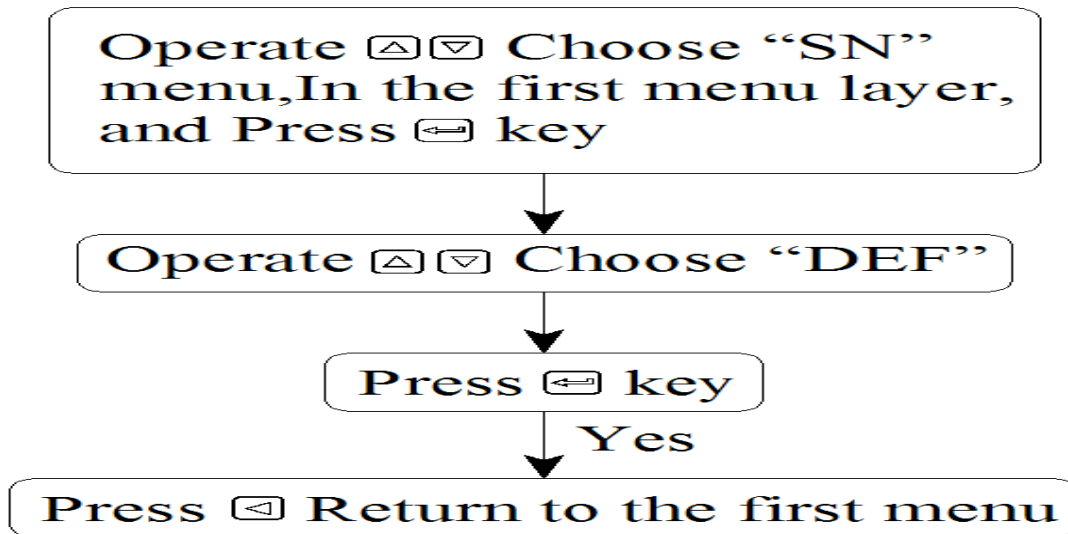

- **Sn—rd** Parameter read means to read the data in the parameter area of EEPROM into the memory. This process will be automatically executed once when power on. At the beginning, the memory parameter value is the same as that in the EEPROM parameter area. However, if the user modifies the parameters, the parameter values in the memory will be changed. When the user is not satisfied with the modified parameters or the parameters are disturbed, the parameter read operation can be performed to read the data in the parameter area of the EEPROM into the memory again. Return to the parameters just after power on.
- **Sn—SS** Parameter backup
- **Sn—rS** Restore the backup area parameters to the current memory
- **Sn—dEF** Restoring the default value means that the default value (factory value) of all parameters is read into the memory and written into the parameter area of the EEPROM, and the default parameter will be used next time the power is turned on. When the user messes up the parameters and cannot work normally, use this operation to restore all parameters to the factory state. Because the parameter default values corresponding to different drive models are different, when using the restore default parameters, you must first ensure the correctness of the motor ID (parameter PN1).

Operation process



3.5 F2 operation mode (jog test machine function)

Select "F2-" in the first layer, and press the key  to enter the jog operation mode. The prompt of JOG operation is "J", the numerical unit is r/min, and the speed command is provided by the key. After entering the F2 operation, press  and hold the key, the motor runs at the jog speed, release the key, the motor stops, and maintain zero speed; press the key  and hold, the motor runs reversely at the jog speed, release the key, the motor stall, maintain zero speed

Jog speed is set by parameter PN22

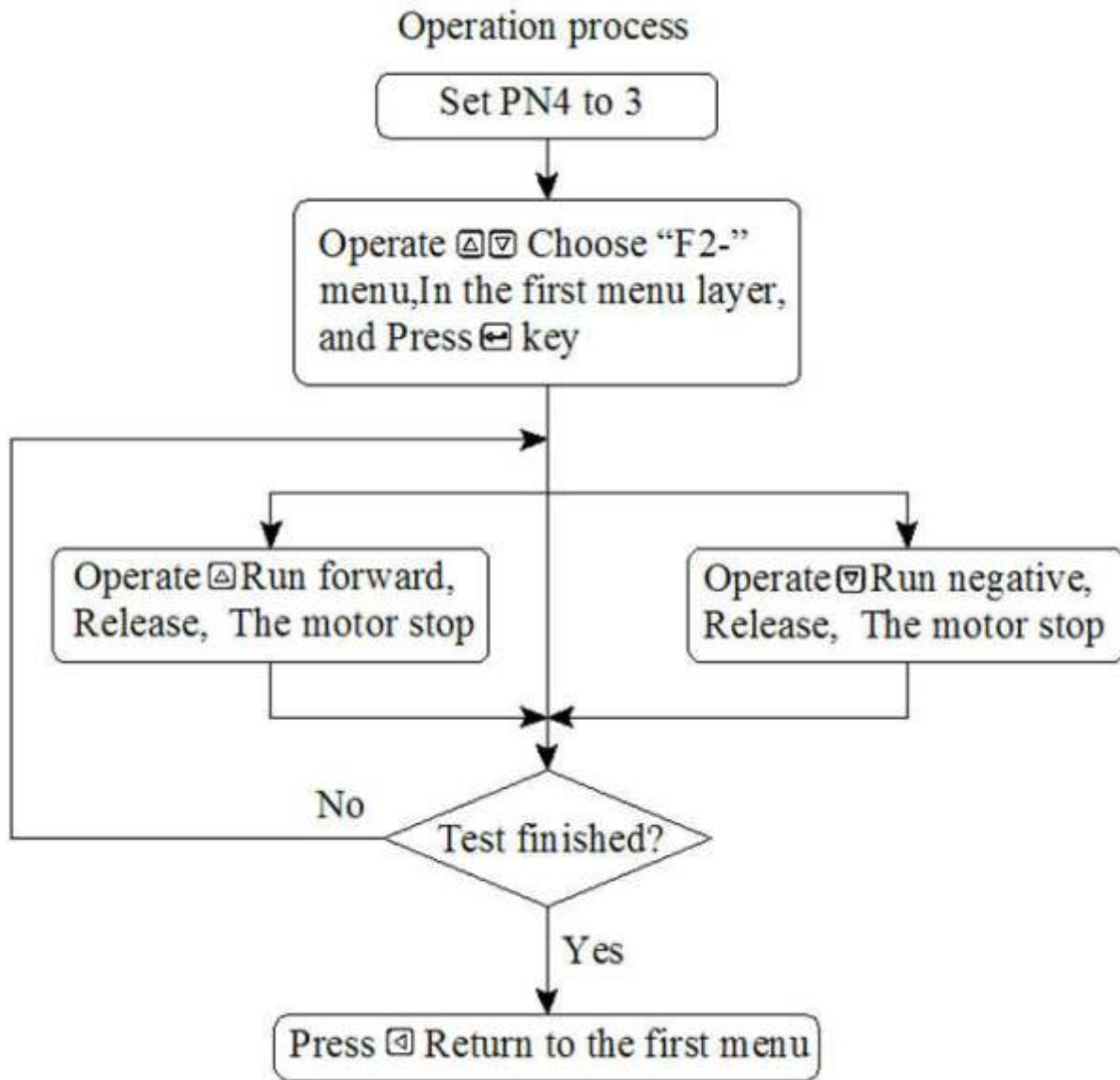

Note: If there is no external enable signal, please set the parameter PN95 to 1. Otherwise the motor cannot rotate

3.6 Other

F4 is the zero adjustment function of the photoelectric encoder, which is used by motor manufacturers and not used by users.

The F5 function is reserved.

Chapter 4 Parameters

SDC series servos have 148 parameters available for adjustment, and adjusting user parameters during use can meet most needs. Do not change the supporting parameters of the motor at will, otherwise unpredictable results will appear. Among them, Pn5-Pn16 are position control parameters, Pn17-42 are speed control parameters, Pn43-Pn50 are current control parameters, and Pn51-Pn59 are I/O control parameters. Pn60-Pn96 are the matching parameters of the motor. Pn97-Pn148 are internal position control parameters and communication control parameters. Take the default parameters as an example.

4.1.0 List of all parameters

No.	Name	default value	No.	Name	default value
0	parameter password	168	21	Arrival speed	500
1	Motor ID	83	22	jog speed	120
2	Software version	4007	23	Enable OFF delay	0
3	initial display state	0	28	reserve	0
4	control mode	0	29	Speed control mode ac/ deceleration time constant	0
5	Position proportional gain	300	30	Orientation control mode ac/ deceleration time constant	0
6	Position Feedforward Gain	0	41	reserve	0
7	Position Feedforward Low Pass Filter Cutoff Frequency	300	43	Current loop proportional gain	130
12	Orientation completion range	200	44	Current loop integral time constant	110
13	Position out-of-tolerance detection range	4000	50	Torque command filter	100
14	Invalid location error	0	58	History alarm record	0
16	drive prohibition method	1	59	reserve	0

Chapter 4 Parameters

17	speed proportional gain	200	60	Motor inertia ratio	220
18	speed integral time constant	160	61	Motor rated torque	24
19	Speed detection low pass filter	580	62	Motor rated speed	3000
20	User RPM Limit	4000	63	Motor Max. speed	6000
64	Motor rated current	50	125	Torque mode speed limit	20
65	Overload multiple	245	126	PWM frequency	100
66	Current Integral Separation Point	800	128	Encoder Angle Compensation	0 60
68	Current Command Low Pass Filter	340	129	Error tolerance times of code disc communication	3
69	Velocity Integral Split Point	200	133	Speed command filter coefficient in position control	350
74	Bus position command format	0	134	Following error compensation coefficient	0
75	Overload torque detection point	130	135	PDO fault tolerance times	0
76	Torque at the overload point	200	137	Counterclockwise friction compensation coefficient	0
77	Maximum overload time at overload point	1000	138	Clockwise friction compensation coefficient	0
79	Speed Amplifier Saturation Detection Time	1500	139	Counterclockwise damping compensation coefficient	0
82	Interval time from enable to the first valid interpolation data in interpolation control	600	140	Clockwise damping compensation coefficient	0
83	Maximum continuous braking time	20	142	Return to zero mode	0
84	Current detection coefficient	500	143	Return to zero speed	0
86	Encoder bits	17	144	the speed to zero point after deceleration	0
87	Code disc battery detection	0	145	Return to zero acceleration	600
88	Current when the code disc is zero-adjusted	60	146	Back to zero bias low	100

Chapter 4 Parameters

89	Motor thermal overload detection starting point	105	147	Back to zero bias high	100
90	Motor thermal overload torque characteristic point	130	148	Recognition range of completion of zero return	0
91	Motor thermal overload time	900			
92	Number of motor pole pairs	5			
93	Position Gain Attenuation Coefficient	2			
94	Torque when the torque arrival signal is valid	150			
95	Force enable	0			
96	Maximum current limit	148			
117	RS485 communication rate	1			
118	RS485 communication rate	5			
119	RS485 communication protocol	0			
120	Speed integral windup fault detection	0			

4.1.1 A detailed list of the function meaning of each parameter

No.	Name	Function	Range
0	parameter password	① The password is divided into levels, corresponding to user parameters and system parameters; ② To modify the motor ID (Pn1), this item must be set to 0, and the user parameter password is 168. Please consult the factory for system parameters.	0~30000
1	Motor ID	For matching motor models. Each motor has only one ID number, and the password Pn0 must be set to 0 before modifying this parameter. After the setting is completed, the SN-DEF needs to be executed to be valid. Please operate this parameter with caution.	0~113
2	Software ID	Reserved for manufacturer use.	
3		Select the display state of the display after the drive is powered on:	0~25

Chapter 4 Parameters

	initial display state	0: Display motor speed 1: Display the lower 5 digits of the current position 2: Display the higher 5 digits of the current position 3: low position 4: high position 5: position deviation low 6: position deviation high 7: Current torque percentage 8: Display motor current 9: Modbus communication error count 10: current control mode 11: Display position command pulse frequency 12: Display speed command 13: Display torque command 14: Displays the low position of the absolute position of the rotor in one revolution 15: Rotor absolute position high 20: alarm number 21: Current motor turns 24: Goal version number 25: Code disc communication error count	
4	control mode	This parameter can be used to set the control mode of the driver: : 0: Ether CAT bus mode 2: speed test run 3: jog control mode 4: Zero mode 5: open loop operation 6: burn-in mode	0~6
5	Position proportional gain	Set the proportional gain of the position loop regulator: The larger the setting value is, the higher the gain is, the larger the stiffness is, and the smaller the position lag is under the condition of the same frequency command pulse. However, if the value is too large, it may cause oscillation or overshoot.	1~10000
6	Position Feedforward Gain	The function of position control is position feedforward, the feedforward gain of the position loop is increased, and the high-speed response characteristics of the control system are improved, but it will make the position loop of	0~100

Chapter 4 Parameters

		the system unstable and easily oscillate. Unless very high response characteristics are required, the feedforward gain of the position loop is usually 0.	
7	Position Feedforward Low Pass Filter Cutoff Frequency	Set the cutoff frequency of the low-pass filter of the position loop feedforward amount. The higher the cutoff frequency, the better the position tracking, but it is easy to oscillate.	1~1200
12	Orient complete range	Set the positioning completion pulse range under position control: This parameter provides the basis for the drive unit to judge whether positioning is completed in position control mode.	0~30000
13	Position out-of-tolerance detection range	Set the detection range of the position out-of-tolerance alarm: In the position control mode, when the count value of the position deviation counter exceeds the value of this parameter, the servo drive unit will give a position out-of-tolerance alarm, and the internal calculation has times multiplied by one hundredth of a circle, for example: 17-bit code disc, the actual out-of-tolerance alarm pulse number is $Pn13*1310.72$	0~30000
14	The out-of-position error is invalid	0: Position overrun alarm detection is valid. 1: The position overrun alarm detection is invalid, and the position overrun error is not detected.	0~1
16	Drive prohibition method	0: CCW、CW Invalid input prohibition; 1: Input port 2 is the CCW drive disable signal, and input port 3CW drive disable. 2: Input port 3 is the CCW drive disable signal, and input port 2CW drive disable.	0~2
17	Speed proportional gain	Set the proportional gain of the speed loop regulator: 1, The larger the setting value, the higher the gain and the greater the stiffness; 2, the larger the load inertia, the larger the setting value.	5~2000
18	Velocity integration time constant	Set the integration time constant of the speed loop regulator: 1, the smaller the setting value, the faster the integration speed and the greater the stiffness; 2, the	1ms ~1000ms

Chapter 4 Parameters

		larger the load inertia, the larger the setting value. Start and stop frequent small power occasions set smaller to prevent overshoot.	
19	Speed detection low pass filter	Set the speed detection low-pass filter characteristics: 1, the smaller the value, the lower the cut-off frequency, the less noise generated by the motor. If the load inertia is large, the setting value can be reduced appropriately. Too small a value causes a slow response and may cause oscillation; 2, the larger the value, the higher the cutoff frequency, the faster the speed feedback response. If a higher speed response is required, the setting value can be increased appropriately.	1~580
20	User speed limit	The maximum speed of the motor can be limited depending on the application.	0~ 6000 r/min
21	Arrival Speed	Sets the speed value when the speed arrival output signal is valid.	0~6000 r/min
22	Jog speed	Set the running speed of the jog movement.	-6000~6000 r/min
23	Enable OFF delay	Enable OFF is activated after the delay of this parameter to prevent the brake motor from dropping when power is lost.	0-30000ms
29	Speed control mode ac/ deceleration time constants	Indicates the number of milliseconds used for acceleration and deceleration of the motor from 0r/min to 1000r/min. The acceleration and deceleration characteristics are linear. When set to 0, the speed acceleration/deceleration does not work and is only used in speed mode.	0 ~32767ms
30	Positioning control ac/deceleration time constants	Indicates the number of milliseconds used to ac/ decelerate the motor from 0r/min to 1000r/min. The ac/deceleration characteristic is linear. When set to 0, the position ac/deceleration does not work, but when set to other values, it can effectively reduce the shock during the position loop commutation and ac/deceleration, and the operation is smoother, and it is only used in the position mode.	0~32767ms
43	Current loop Proportional gain	1, the larger the setting value, the higher the gain, the smaller the current tracking error, but the gain will be too large to produce oscillation or noise; 2, related to the servo and motor; 3, not related to the load.	1 ~ 500

Chapter 4 Parameters

44	Current loop integration time constant	1, the smaller the setting value, the faster the integration speed, the smaller the current tracking error. But the integration is too small will produce oscillation or noise; 2, related to the servo and motor; 3, independent of the load; 4, under the condition that the system does not produce oscillation, try to set a larger.	1~10000
50	Torque command filter	1, set the torque command filter characteristics. It can suppress the resonance generated by the torque (sharp vibration noise from the motor). 2, the smaller the value, the lower the cut-off frequency, the less noise generated by the motor. If the load inertia is large, the setting value can be reduced appropriately. The value is too small, causing a slower response and may cause instability.	1~500
58	Historical alarm records	Record the last alarm log.	0~50
60	Motor Inertia ratio	Set the motor inertia ratio.	1~32767
61	Motor rated torque	Set the rated torque of the motor.	1~1000
62	Motor rated speed	Set the rated speed of the motor.	0~6000 r/min
63	Max. motor speed	Set the maximum motor speed.	0~8000 r/min
64	Motor rated current	Set up the rated current (unit 0.1A). The setting value is an effective value.	1~500
65	Overload	Set the maximum overload multiple of the system.	0~300%
66	Current integration separation point	When the current error exceeds this setting value, the current loop changes from PI to P. The value is a percentage of the rated current.	0~800%
68	Current command low-pass filter	Sets the current command low-pass filter cutoff frequency. Used to limit the current command band to avoid current shocks and oscillations and make the current response smooth.	1~1500HZ
69	Speed integral separation	When the speed deviation exceeds this setting value, the speed PI becomes P.	0~300

Chapter 4 Parameters

	point		
74	Bus position command form	According to the upper computer setting 0: Incremental interpolation, the motor goes according to the increment of the position command 1: absolute interpolation, the motor goes according to the absolute value of the position command	0-1
75	Overload torque detection point	Set the starting torque value of overload protection, the percentage of rated When the current torque of the motor is higher than this value, the internal overload counter of the system works, and when the count value exceeds, the system outputs an overload alarm.	0-300%
76	Torque at the overload characteristic point	Set the torque at the overload point, this parameter and Pn77 together form the overload characteristic of the motor, which is set based on the motor overload characteristic parameter, note that Pn76» Pn75.	0-300%
77	Max. overload time at the overload point	Refer to Pn76.	0-3000×10 ms
79	Speed amplification Device saturation time	A speed saturation alarm is generated when the system's internal speed regulator is continuously saturated for longer than this value. Used to prevent mechanical jamming or other causes of high continuous current.	0-3000×10 ms
82	Interval between enable and first interpolation data in interpolation control	Position commands prior to this time are ignored (in 0.1ms)	1-10000
83	Max. continuous braking time	Alarm if braking exceeds this setting	2~200

Chapter 4 Parameters

84	Current detection	Current detection coefficient	1~32767
86	Encoder bits	17 or 23 bits	17
87	Code plate battery detection	0: No detection of code panel battery. 1: Detect code tray battery and alarm is valid.	0~1
88	Current at code plate zeroing	Set the current level of the encoder when zeroing, as a percentage, not too large to prevent the motor from overheating.	0~100%
89	Motor thermal overload detection start point	The thermal overload is calculated using the I*I*T method.	10~300%
90	Motor thermal overload torque characteristic point	This parameter is set larger than Pn89.	10~300%
91	Motor thermal overload time	Set the maximum time for thermal overload.	0~1000S
92	Number of motor pole pairs	Set the number of pole pairs of servo motor, different manufacturers and different models, the motor may be different, you can not change this parameter at will.	1~36
93	Position gain attenuation coefficient	In the high position gain state, reduce the jitter or noise when the motor is stationary, the larger the parameter, the more obvious the effect.	1~3000
94	Torque when the torque arrival signal is valid	The analog control torque reaches this setting value, the torque arrival output signal is valid, the value is a percentage of the rated torque.	0~300%
95	Forced Enable	0: No servo enable or enable by communication control. 1: Automatic servo enable after forced power on, no	0~1

Chapter 4 Parameters

		external signal is required.	
96	Max. current limit	The user is not allowed to change it and the value is the maximum value.	154
117	Communication address	Set station number for Modbus communication.	0-127
118	Communication rate	Communication rate: 0: 4800 1: 9600 2: 19200 3: 38400 4: 57600 5: 115200	0-5
119	communication protocol	Transmission protocol, using RTU mode: 0: 8 0 1 (MODBUS, RTU) ; 1: 8 E 1 (MODBUS, RTU) ; 2: 8 N 2 (No parity, 2 stop bits) 3: 8 N 1 (No parity, 1 stop bit) Note: 8 indicates 8 bits of data; E indicates even parity; 0 indicates odd parity; 1 indicates 1 stop bit. 0 means odd parity; 1 means 1 stop bit; N means no parity	0-3
120	Speed integration saturation fault detection	0: detects saturation faults. 1: No detection of saturation faults.	0-1
125	Torque mode speed limit	The torque control mode limits the speed.	0-4000
126	PWM frequency	Manufacturer use	40-120
128	Encoder angle compensation	Manufacturers use, modify with caution.	-1000-1000
129	Fault tolerance range for code plate communication	Code wheel communication error tolerance times.	0~10000
130/		Manufacturers use, modify with caution.	

Chapter 4 Parameters

131			
133	Speed command filter coefficient in position control	Filter coefficient for converting position command to speed	350
134	Follow error compensation coefficient	Adding this parameter setting can reduce the position following error, and it is used in the case that the upper computer has acceleration and deceleration.	0-100
137	Counterclockwise friction compensation coefficient	The unit of this parameter is one 1000th of the rated torque, see the torque setting parameter, see the torque monitoring (UN8) within 10 rpm, how much is displayed and how much can be set.	
138	Clockwise friction compensation coefficient		
139	Counterclockwise damping compensation coefficient	Damping compensation, the motor turns to the rated speed, look at the torque command, the torque monitoring value in the forward direction minus the parameter value of 137 can be, such as can not reach the rated speed, then set by proportional calculation	
140	Clockwise damping compensation coefficient		
142	Return to zero mode	Refer to CIA402 standard	0-34
143	Return to zero speed	Motor speed at rapid return to zero	0~3000 r/min
144	Find zero point speed	Slow speed of zeroing after touching the switch	0~100 r/min
145	Return to zero acceleration	The number of milliseconds used for acceleration and deceleration from 0r/min to 1000r/min during the motor return to zero, 0 means no acceleration and deceleration	0-30000
146	Return to zero bias low	The absolute position of the motor turn corresponding to the zero point	
147	Return to zero bias high		

148	Recognition range of completion of zero return	If the deviation between the motor position and the set zero point is less than this setting, the return to zero is considered complete.	
-----	--	--	--

4.2 Parametric debugging block diagram model

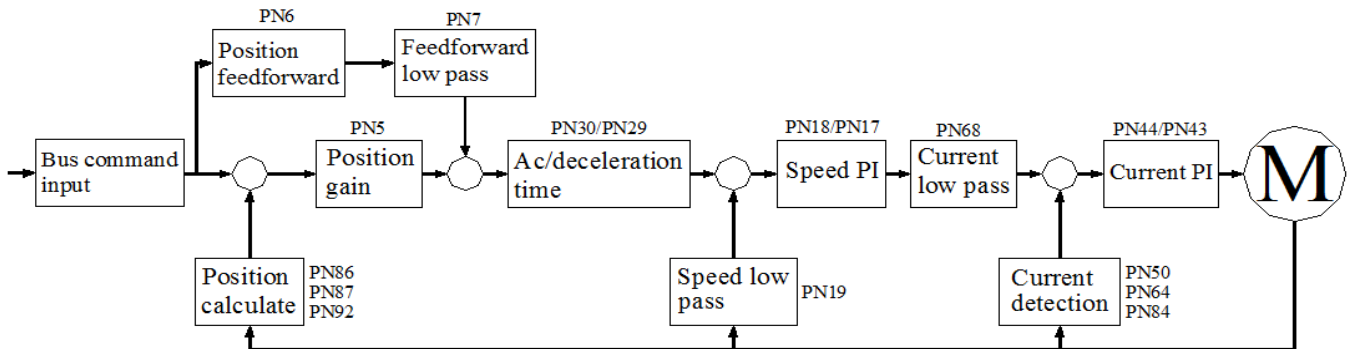

Parameter debugging block diagram model

4.3 Servo key parameters description

Since the default motor package parameters have been optimized, in most applications there is no need to adjust the parameters and can be used directly. However, actual machinery is complex and diverse. If abnormalities occur during commissioning or if ultra-high response is required, the parameters need to be adjusted to meet the requirements. The principle of commissioning is current loop first, then speed loop, and finally position loop.

The current loop is generally not adjusted, except for individual occasions. The speed response is too fast, causing current inrush. Resulting in AL11 alarm. Can be solved by adjusting PN64.

Speed loop: When high speed response is required, PN17 can be increased or PN18 can be decreased to obtain it. However, PN17 is set too large and prone to vibration. In the case where the load inertia is too large, if the load motor movement is unstable when decelerating and shaking from side to side, it is necessary to increase PN18 to solve the problem.

Position loop: In cases where a higher position response is required, PN5 can be increased to obtain it. Some occasions also need PN6 to be increased to meet. However, PN5 PN6 setting is too large and prone to

vibration. The premise of the setting is to prioritize the commissioning of Pn5, and Pn6 is used only at short distances and high response.

4.4 Steps for debugging parameters in practical applications

In the process of commissioning or application, if vibration, noise or failure to achieve control accuracy is found; the parameters of the system can be adjusted as follows to meet the control requirements.

When the motor is in a static locked state, if vibration or sharp noise occurs, please turn down the parameter value of Pn43; under the condition that no oscillation occurs, this parameter is set as large as possible. The larger it is, the better the current tracking effect and the faster the motor response; but too large is prone to vibration or noise.

(1) : Speed control mode parameter adjustment:

1) The setting value of [Speed proportional gain] (parameter Pn17) should be set as large as possible under the condition that no oscillation occurs. In general, the larger the load inertia is, the larger the setting value should be;

2) The setting value of [velocity integration time constant] (parameter Pn18) should be set as small as possible for the given conditions. If the setting is too small, the response speed will increase, but oscillation will occur easily. Therefore, try to set it as small as possible under the condition that no oscillation occurs. If the setting is too large, the speed will change more when the load changes.

(2) : Position control mode parameter adjustment:

1) First, set the appropriate [speed proportional gain] and [speed integration time constant] as above;

2) [Position feedforward gain] (parameter Pn6) is set to 0%;

3) The setting value of [Position proportional gain] (parameter Pn5) is set as large as possible in the stable range. When the setting is too large, the tracking characteristics of the position command are good and the hysteresis error is small, but oscillation is easily generated when stop positioning. When the setting is small, the system is in a stable state, but the position tracking characteristics become poor and the hysteresis error is large.;

4) If particularly high position tracking characteristics are required, the Pn6 setting can be increased; however, if it is too large, it will cause overshoot.

Chapter 5 Operation and Commissioning

5.1 Special notes on commissioning:

- 1) (Medium and high power suffix K8) The servo driver will connect AC three-phase power to the power input terminals. Three-phase connected to L1, L2, L3, single-phase connected to L2, L1;
- 2) (Small power model suffix K7) Servo driver single-phase connected to L, N;
- 3) Motor power line U, V, W, PE, the order must not be connected in reverse;
- 4) The above part is the connection of the drive if the wrong connection may lead to burn, motor does not turn, alarm and other phenomena, please check carefully whether the connection is wrong, connected to the reverse.

5.1.1 Power On Sequence

The servo output signal is valid after the power is turned on for 1S, and then the servo is ready and able to respond to the enable signal after 1.5S, waiting for operation.

5.2 Position control mode operation

- 1) Turning on the control circuit power supply and the main circuit power supply, and the display of the driver unit lights up.

If an alarm appears, please check the connection.

- 2) The relevant parameters are as follows:

Parameter No.	Parameter Name	Definition	Set value
Pn4	Control Mode	0: EtherCAT bus mode	0
Pn5	Position proportional gain	Enlargement can reduce position deviation and improve system rigidity	300
Pn30	Position ac/ deceleration	Ac/deceleration in position mode to reduce the vibration when changing direction.	0

Chapter 5 Operation and Commissioning

Pn 41	Code wheel feedback one circle resolution	Used to feed back the position of the code disc to the host computer	10000
Pn 59	Z signal width ratio	Widen the Z signal to facilitate the host computer to receive	0
Pn95	Servo enable	0: External enable 1: Forced enable	1

3) After confirming that there is no alarm or any abnormal condition, make the servo enable (SON) ON, then the motor will be excited and in zero speed state. If the enable signal is not wired, you can set Pn95 to 1 to automatically enable the motor.;

4) Connects to a bus-enabled host computer to run the motor as instructed.



5.3 jog operation

1) Turn on the control circuit power and the main circuit power, and the display of the driver unit lights up. If an alarm appears, check the connection..

2) Set the following parameters:

Parameter No.	Parameter Name	Definition	Set value
Pn4	Control Mode	3: jog operation	3
Pn95	Servo enable	0: External enable 1: Forced enable	1

3) After confirming that there is no alarm or any abnormal condition, make the servo enable (SON) ON, then the motor will be excited and in zero speed state. If the enable signal is not wired, you can set Pn95 to 1 to automatically enable the motor.

4) Enter the F2 jogging operation state by key operation, the JOG operation prompt is "J", the value unit is r/min, the system is in the speed control mode, the speed and direction are determined by the parameter Pn22, press  motor is running in speed and direction determined by the Pn22 parameter, press  motor runs in reverse at a given speed.

Chapter 6 RS485 Communication

6.1 RS485 communication hardware interface

6.1.1 RS485 Communication

This servo driver adds RS485 communication function, which can drive servo system, change parameters, monitor servo system status and many other functions. to adapt to specific application requirements.

6.1.2 External connection diagram

External Sketch

HMI/PLC etc. Controller

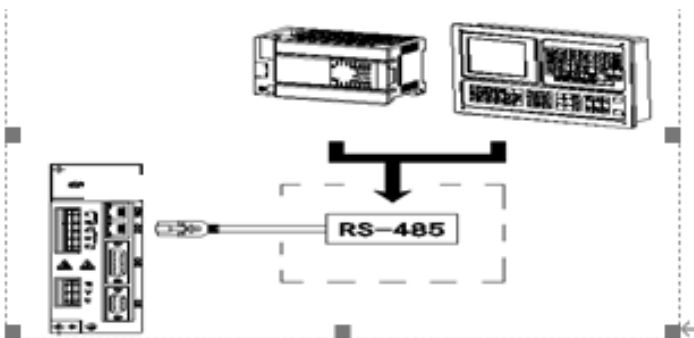

6.1.3 multi-unit external connection diagram

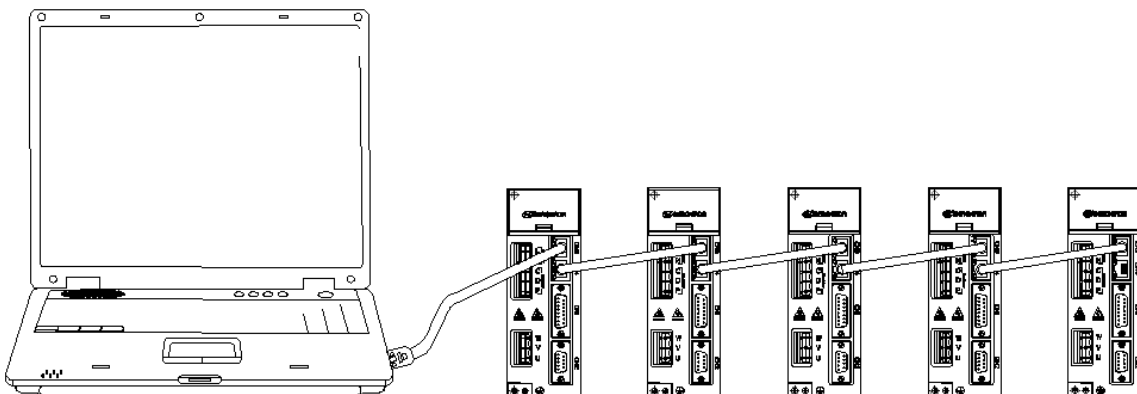

6.2 Communication protocols

This servo system adopts the standard asynchronous serial master-slave MODBUS communication protocol. Only one device master in the network can initiate communication, and other device slaves can only respond to the commands of the master by providing data or do the corresponding actions according to the commands of the master. The host refers to a personal computer, industrial control equipment or PLC, etc., and the slave refers to this servo system.

When a communication command is sent from the sending device (host) to the receiving device (slave), the slave that matches the corresponding address code receives the communication command, reads the information according to the function code and related requirements, executes the corresponding task if the CRC check is correct, and then returns the execution result (data) to the host. The returned information includes the address code, function code, executed data and CRC check code. If the CRC checksum is wrong, no information is returned.

Communication frame structure in RTU mode

6.2.1 Communication command code and data description

Function Code	Definition	Operation (binary)
03	Read register data	Read data from one or more registers
06	Write single circuit register	Writes a set of binary data to a single register
10	Writing multiplex registers	Writing multiple sets of binary data to multiple registers

6.2.2 Function code "03": Read multiplexed register input

For example, the host wants to read the data of 3 slave registers with address 01 and starting address 0116.

The address and data of the slave (PDM) data register are:

Register Address	Register data (hexadecimal)	Corresponding PDM power
0116	1784	UA
0117	1780	UB
0118	178A	UC

Format of the message sent by the host:

Host sending	Number of bytes	Messages sent	Note
Slave Address	1	01	Send to the slave with address 01
Function Code	1	03	Read register
Start Address	2	0116	Starting address is 0116
Data Length	3	0003	Read 3 registers (6 bytes in total)
CRC Code	2	E5F3	Calculated by the host to get the CRC code

Format of the message returned by the slave (PDM) response:

Slave Response	Number of bytes	Returned information	Note
Slave Address	1	01	From Slave 01
Function Code	1	03	Read register
Read Word	1	06	3 registers totaling 6 bytes
Register Data 1	2	1784	Contents of memory at address 0116
Register Data 2	2	1780	Contents of memory at address 0117
Register Data 3	2	178A	Contents of memory at address 0118
CRC Code	2	5847	The CRC code is calculated by the slave

6.2.3 Function code "06": Write single circuit register

For example, the host wants to write data 07D0, to the slave register with address 002C (slave address code is 01). After the communication data is written, the original storage information of PDM table with address 002C is:

Address	Original stored data (hexadecimal)
002C	04B0

Format of the message sent by the host:

Host sending	Number of bytes	Messages sent	Example
Slave Address	1	01	Send to the slave with address 01
Function Code	1	06	Write single circuit register
Start	2	002C	Address of the register to be

Address			written
Write data	2	07D0	Corresponding new data
CRC Code	2	4BAF	CRC code calculated by the host

Format of the message returned by the slave (PDM) response:

Exactly the same format and data content as the message sent by the host.

6.2.4 Function code "10": Write multiplex register

The host uses this function code to write multiple data to the data memory of the PDM table. registers in the Modbus communication protocol refer to 16 bits (i.e. 2 bytes) and the high bit comes first. This way the PDM memory is all two bytes. Since the Modbus communication protocol allows to save up to 60 registers at a time, the PDM also allows to save up to 60 data registers at a time

For example, the host wants to write 0064, 0010 to the slave register with address 002C, 002D (slave address code is 01). After the communication data is written, the information stored in the PDM table with address 002C/002D is:

address	Original stored data (hexadecimal)
002C	04B0
002D	1388

Format of the message sent by the host:

Host sending	Number of bytes	Messages sent	Example
Slave Address	1	01	Send to slave 01
Function Code	1	10	Writing multiplex registers
Start Address	2	002C	Starting address of the register to be written
Write-in data word length	2	0002	Word length for writing in data (2 words total)
Write data	1	04	Length of bytes of written data (4

byte length			bytes total)
Write data 1	2	04B0	Data Address 002C
Write data 2	2	1388	Data Address 002D
CRC Code	2	FC63	CRC code calculated by the host

Slave (PDM) response return message format:

Slave Response	Number of bytes	Returned information	Example
Slave Address	1	01	From Slave 01
Function Code	1	10	Writing multiplex registers
Start Address	2	002C	Starting address is 002C
Write-in data word length	2	0002	Write 2 words of data length
CRC Code	2	8001	CRC code calculated by the slave

6.2.5 Error Checksum (CRC Checksum):

The host or slave can use the check code to discern whether the received information is correct or not. Due to electronic noise or some other interference, information may sometimes be incorrect during transmission. The error check code (CRC) can check whether the host or slave has incorrect information during communication data transmission, and the incorrect data can be discarded (either sent or received), which increases the safety and efficiency of the system.

The CRC (redundant cyclic code) of the MODBUS protocol consists of 2 bytes, i.e. 16 binary digits, which are calculated by the sending device (master) and placed at the end of the sent message frame. The device receiving the message (slave) then recalculates the CRC of the received message, compares the calculated CRC with the received one, and if they do not match, an error is indicated.

Only 8 data bits are used in the CRC calculation, the start bit,

stop bit and parity bit are not involved in the CRC calculation.

- The CRC code is calculated as:

1. Presets one 16-bit register to hexadecimal FFFF (i.e., all 1s); call this register a CRC register;

2. Isochronize the first 8 bits of binary data (the first byte of the communication information frame) with the lower 8 bits of the 16-bit CRC register and place the result in the CRC register;

3. Shift the content of the CRC register one bit to the right (toward the low bit) to fill the highest bit with a 0, and check the shifted out bit after the right shift;

4. If the move out bit is 0: repeat step 3 (shift right one bit again);

If the bit shifted out is 1: XOR the CRC register with the polynomial A001 (1010 0000 0000 0001);

5. Repeat steps 3 and 4 until the right shift is 8 times, so that the entire 8-bit data is processed;

6. Repeat steps 2 to 5 to process the next byte of the communication information frame;

7. After all the bytes of the communication information frame are calculated according to the above steps, the high and low bytes of the 16-bit CRC register obtained are exchanged;

8. The final content of the CRC register is: CRC code.

6.3 Communication error information and data processing:

When the PDM meter detects an error other than the CRC code error, it must send information back to the master. The highest position of the function code is 1, that is, the function code sent back from the slave to the master is 128 on the basis of the function code sent by the master. The code below indicates that an unexpected error has occurred.

If the information received by PDM from the host has a CRC error, it will be ignored by the PDM table.

The format of the error code returned by PDM is as follows (except CRC code):

Address code: 1 byte

Function code: 1 byte (the highest bit is 1)

Error code: 1 byte

CRC code: 2 bytes.

The PDM response returns the following error code:

81. illegal function code.

The received function code PDM table does not support.

82. invalid data location.

The specified data location is outside the range of the PDM table.

83. invalid data value.

The data value received from the host exceeds the data range of the corresponding address of the PDM.

6.5 Examples of communication commands

RTU commands: 03 read single or multiple registers
 06 write single register
 10 write multiple registers

6.5.1 Application example:

Read multiple registers (eg read PN9 PN10)

01 03 00 09 00 02 14 09
 Station No read command address 9 2 data parity digit
 return

01 03 04 00 01 00 01 6A 33

Return result: 4 bytes. The two parameters are 01 and 01 respectively. That is, PN9 PN10=1

Write multiple registers (eg write PN9 PN10)

01 10 00 09 00 02 04 00 05 00 04 22 07
 Station No write command add. 9 2 data 4 bytes Data 5 and 4 check code
 return

01 10 00 09 00 02 91 CA

Return result: two byte parameters have been written, check the drive, PN9=5 PN10=4

01 Read a single register (for example, read the current size of the servo output, that is, the UN-I address is 309)

02 03 01 35 00 01 95 F8

Return: 01 03 02 00 03 F8 45 means that the read data is 03 means 0.3A

For example: read current motor position UN-2 UN-3

01 03 01 2E 00 02 A5 FE

Return: 01 03 01 F5 B1 00 03 D9 D9

F5B1=62897 0003=03

So the current position is 0362897

01 06 00 5F 00 01 78 18: Use communication to modify PN95=1 to control motor enable

01 06 00 04 00 02 49 CA: Use communication to modify PN4=2

SDC Common communication address

Motor speed	012DH
The lower 5 bits of the current position of the motor	012EH

The higher 5 bits of the current position of the motor	012FH
motor torque	0134H
motor current	0135H
frequency pulse	0138H
speed command	0139H
Torque command	013AH

Note:

①. Read the address of the monitoring menu, mainly through 485 communication, let the host computer read it, and use it to transmit the servo status to the host computer.

②. Monitoring menu address: 12DH ~ 148H, the sequence is the same as the original driver

③. Read the address of the input port I00-I02, used to read the state of the input point through communication.

The input port address is 122H ~ 128H, the output port address is 129H /12AH /12BH

④. The communication port standard adopts SDC servo software to debug, and can also use the computer serial port to debug. Debugging with a computer must be connected to a USB-to-RS485 converter.

6.5.2 SDC servo system communication address list

Communication project	Communication address	Read/write status
Servo parameters	0-00FFH	Readable and writeable
Input port status	0122H-0128H	Read only
Output port status	0129H-012BH	Read only
Monitor menu content	012DH-0148H	Read only

Chapter 7 EtherCAT Communication Functions

7.1 EtherCAT Communication Fundamentals

7.1.1 EtherCAT Communication

EtherCAT stands for Ethernet for Control Automation Technology and is a real-time Ethernet master-slave communication method developed by BECKHOFF in Germany and managed by ETG.

7.1.2 EtherCAT State Machine

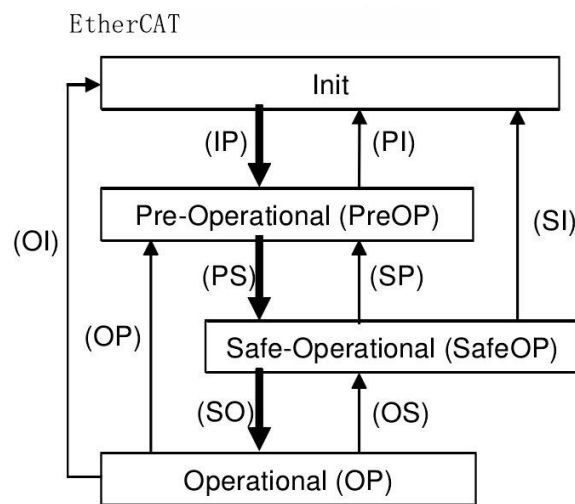

The state of the EtherCAT application layer (ESM state) is shown in the diagram:

Fig. 7-1 State transition diagram

EtherCAT must support 4 states, which are responsible for coordinating the state relationship between the master and slave applications in the initialization and running states.

When transforming from the initialized state to the running state, the sequence of "initialization→pre-running→safe running→running" must be followed. When returning from the running state, it is possible

Chapter 7 EtherCAT Communication Functions

to go beyond the level. The conversion operation and initialization process of the state are as follows:

Status	Actions acquired in each state	Communication actions		
		SDO (Mailbox) S/R mail	PDO Send mail (Slave to Master)	PDO Receive mail (Master to Slave)
Init	In the initialization of the communication section, SDO (Mailbox) sends and receives letters, and PDO cannot send and receive letters in the state	-	-	-
Pre-Operational (:PreOP)	SDO (Mailbox) The state of being able to send and receive letters	Yes	-	-
Safe-Operational (:SafeOP)	In addition to the SDO (Mailbox), you can send and receive messages via the PDO's outgoing message (slave to master) status.	Yes	Yes	-
Operational (:OP)	SDO (Mailbox) send and receive letters, PDO send and receive all feasible state	Yes	Yes	Yes

7.2 Communication simultaneous mode

Concurrent Mode	Content	Concurrent Method	Features
DC	SYNCO Event Simultaneous	Time information of other slaves based on the time of the 1st axis for the same period	High accuracy. Compensation processing on the master side is required.
SM2	SM2 events during the same period	xPDO's incoming mail events for the same period	Poor accuracy without transmission delay compensation. Be sure to guarantee the transmission time on the upper controller side (dedicated hardware, etc.).
FreeRun	Non-contemporaneous	Non-contemporaneous	Simple processing; lack of real time.

Mailbox Data SDO

This series supports SDO (Service Data Object), which uses Mailbox communication for data exchange, so please note that the data refresh time of SDO becomes unstable, and the master side reads and writes data in the records in the object dictionary, and can perform object setting and monitor various states of the slave.

If the SDO data exchange processing (read/write) fails, an alarm message with an Abort code called Abort message is returned; Abort message is only for SDO data exchange processing, there is no Abort message for PDO data exchange processing. The content of the Abort code

may vary depending on the access conditions.

Process Data PDO

For the transfer of EtherCAT real-time data, the data exchange is performed via PDO's. The PDO's are RxPDO for transfer from master to slave and TxPDO for transfer from slave to master.

	Delivery side	Receiving side
RxPDO	Main Site	Slaves
TxPDO	Slaves	Main Site

1) PDO Mapped objects

PDO mapping refers to the mapping from the object dictionary to the application object of the PDO, with a PDO mapping offset of 0x40 for each servo axis.

2) PDO Assigned objects and list

Because of PDO data exchange, the table for PDO mapping must be allocated to SyncManager. The SyncManager PDO allocation object describes the relationship between the table for PDO mapping and SyncManager. As a SyncManager PDO allocation object, you can use RxPDO (SyncManager2) with 1C12h, TxPDO (SyncManager3) with 1C13h.

An allocation object is the maximum number of application objects that can be allocated as shown below. Usually, since 1 mapping object is sufficient, the default does not need to be changed.

index	sub-index	Name	Instructions	Value range	Default
	0x00	No. of sub-indexes	Configurable	0~0xA	0x6
0x1600	0x01	First mapped object	Configurable	0~0xFFFFFFFF	0x60400010
	0x02	Second mapped object	Configurable	0~1xFFFFFFFF	0x607A0020
	0x03	Third mapped object	Configurable	0~2xFFFFFFFF	0x60FF0020
	0x04	Forth mapped object	Configurable	0~3xFFFFFFFF	0x60710010
	0x05	Fifth mapped object	Configurable	0~4xFFFFFFFF	0x60B80010
	0x06	sixth mapped object	Configurable	0~5xFFFFFFFF	0x60600008
	0x07	seventh mapped object	Configurable	0~6xFFFFFFFF	
	0x08	eighth mapped object	Configurable	0~7xFFFFFFFF	
	0x09	nineth mapped object	Configurable	0~8xFFFFFFFF	
	0x0A	Tenth mapped object	Configurable	0~9xFFFFFFFF	
	0x00	No. of sub-indexes	Configurable	0~0xA	0x9
0x1A00	0x01	First mapped object	Configurable	0~0xFFFFFFFF	0x603F0010
	0x02	Second mapped object	Configurable	0~1xFFFFFFFF	0x60410010
	0x03	Third mapped object	Configurable	0~2xFFFFFFFF	0x60640020
	0x04	Forth mapped object	Configurable	0~3xFFFFFFFF	0x606C0020
	0x05	Fifth mapped object	Configurable	0~4xFFFFFFFF	0x60770010
	0x06	sixth mapped object	Configurable	0~5xFFFFFFFF	0x60B90010
	0x07	seventh mapped object	Configurable	0~6xFFFFFFFF	0x60BA0020
	0x08	eighth mapped object	Configurable	0~7xFFFFFFFF	0x60BC0020
	0x09	nineth mapped object	Configurable	0~8xFFFFFFFF	0x60610008
	0x0A	Tenth mapped object	Configurable	0~9xFFFFFFFF	

Distributed Clocks

The Distributed Clock enables all EtherCAT devices to use the same system time and thus control the synchronization of the individual device tasks. The slave devices can generate synchronization signals based on the synchronized system time. In this driver series, only DC synchronization mode is supported, and the synchronization period is implemented by a SYNC0 event of the EtherCAT master server, which varies depending on the operating mode.

7.3 Drive Mode

7.3.1 Servo state machine

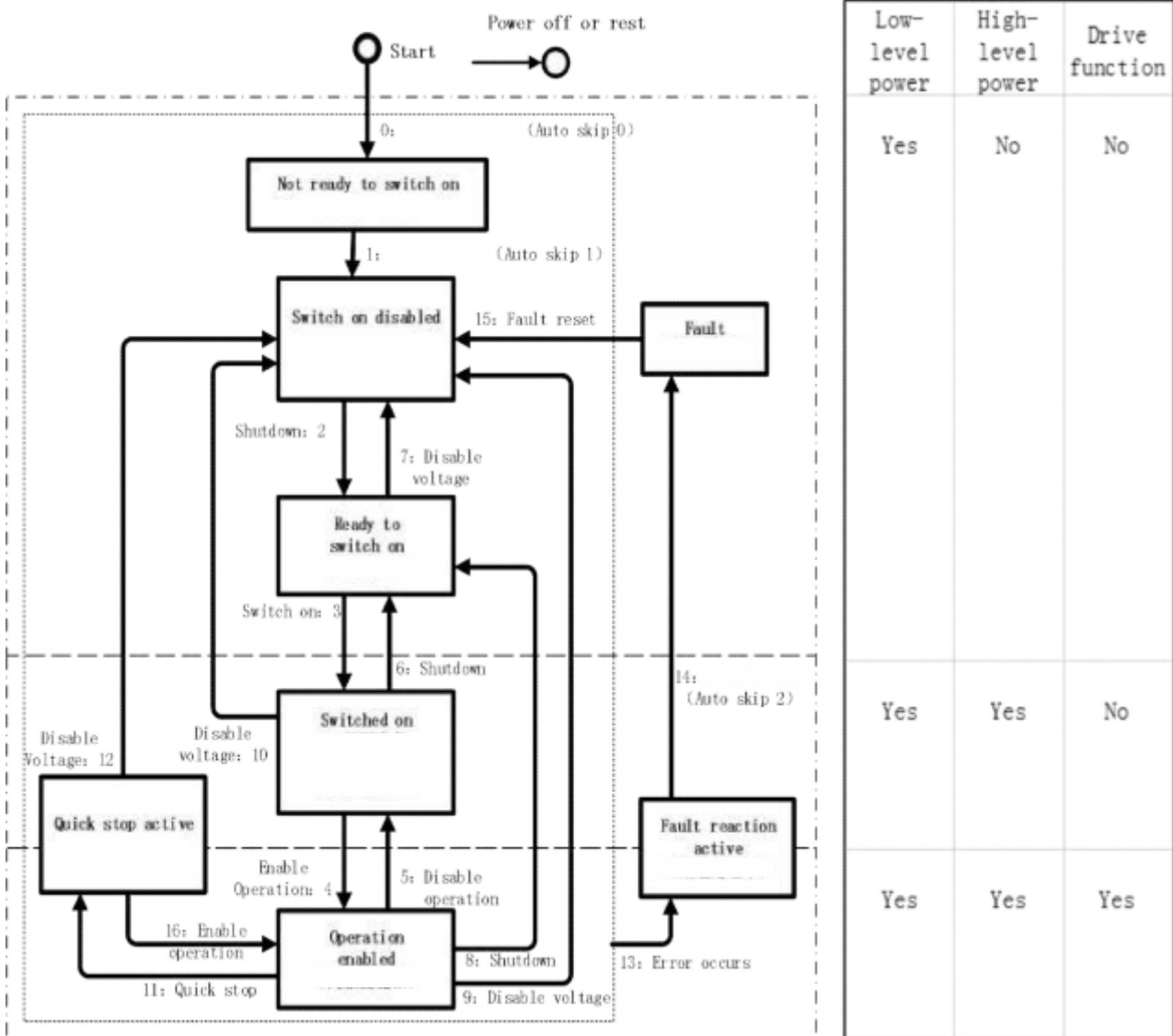

Fig. 7-2 State transition diagram

The condition for the Servo Ready state is that the High-level power is in the ON state. If the High-level power is OFF or not in the Servo Ready state, it cannot be switched to the Switched On state. After transitioning to Operation Enabled, wait for at least 100ms before inputting a motion command.

The operation mode can be changed by 6060h (operation mode).

Chapter 7 EtherCAT Communication Functions

The selection of the server operation mode is performed simultaneously with the change of the associated target. If the primary server is switched to a new operating mode, it is immediately switched to the same mode.

CiA402 Status Switching		Control word 6040h	Status word 6041h
0	Start→Not ready to switch on	Natural transition without control commands	0000h
1	Not ready to switch on→Switch on disabled	Natural transition without control commands If an error occurs during initialization, go directly to 13	0270h
2	Switch on disabled→Ready to switch on	0006h	0231h
3	Ready to switch on→Switched on	0007h	0233h
4	Switched on→Operation enabled	000Fh	1237h
5	Operation enabled→Switched on	0007h	0233h
6	Switched on→Ready to switch on	0006h	0231h
7	Ready to switch on→Switch on disabled	0000h	0270h
8	Operation enabled→Ready to switch on	0006h	0231h
9	Operation enabled→Switch on disabled	0000h	0270h

Chapter 7 EtherCAT Communication Functions

10	Switched on→Switch on disabled	0000h	0270h
11	Operation enabled→Quick stop active	0002h	0217h
12	Quick stop active→Switch on disabled	Quick stop mode 605A is selected from 0 to 3, after the stop is completed, the transition is natural and no control command is required.	0270h
13	→Fauh reaction active	If the Servo Drive fails in any state other than "fault", it will automatically switch to the fault stop state without a control command.	02B6h
15	Fault→Switch on disabled	0080h bit7 rising edge is valid; bit7 is kept as 1, other control instructions are invalid.	0270h

7.3.2 Control word 6040h

Index	Sub-Index	Name	Range	Data Type	Access	PDO	OP-mode
		Controlword	0-65535	U16	rw	RxPDO	ALL
	00h	Set control commands:					
		bit	Name	Description			
		0	Switch on	Invalid			
		1	Enable voltage	Invalid			
		2	Quick stop	Available			
		3	Enable operation	Available			
		4~6	Operation mode specific	Related to each servo operation mode			
		7	Fault reset	Invalid			

Chapter 7 EtherCAT Communication Functions

		8	halt	For the pause method in each mode, please check Consult the object dictionary 605Dh
		9~15	Operation mode specific	Reserved

7.3.3 Status word 6041h

Index	Sub-Index	Name	Range	Data Type	Access	PDO	OP-mode
		Statusword	0-65535	U16	ro	TxPDO	ALL
		Set control commands:					
		bit	Name	Description			
	00h	0	Ready to switch on	1- Valid, 0- Invalid			
	00h	1	Switch on	1- Valid, 0- Invalid			
	00h	2	Enable operation	1- Valid, 0- Invalid			
	00h	3	Fault	1- Valid, 0- Invalid			
	00h	4	Enable voltage	1- Valid, 0- Invalid			
	00h	5	Quick stop	0- Valid, 1- Invalid			
	00h	6	Switch on disabled	1- Valid, 0- Invalid			
	00h	7	Warning	1- Valid, 0- Invalid			
	00h	8	Manufacturer-specific	Undefined functions			
	00h	9	remote	1 - valid, the control			

Chapter 7 EtherCAT Communication Functions

				word is in effect. 0-Invalid
		10	Target reach	1- Valid, 0-Invalid
		11	Internal limit active	1- Valid, 0-Invalid
		12~13	Operation mode specific	Related to each servo operation mode
		14	Manufacturer-specific	Undefined functions
		15	Home find	1- Valid, 0-Invalid

7.3.4 Operation mode setting 6060h

Index	Sub-Index	Name/ Description			
6060h	00H	Val	Operation display mode	Abbre	Cor
		ue		viati	res
				ons	pon
					den
					ce
		1	Profile position mode (Profile	pp	Yes
		3	Profile velocity mode (Profile)	pv	Yes
6	Homing mode	hm	Yes		
8	Cyclic synchronous position mode	csp	Yes		
9	Cyclic synchronous velocity mode	csv	Yes		
10	Cyclic synchronous torque mode	cst	Yes		

7.3.5 Current operating mode display 6061h

Index	Sub-Index	Name/ Description			
6061h	00H	Val	Operation display mode	Abbre	Cor
		ue		viati	res
				ons	pon
					den
					ce
		1	Profile position mode(Profile	pp	Yes
		3	Profile velocity mode(Profile	pv	Yes
6	Homing mode	hm	Yes		
8	Cyclic synchronous position mode	csp	Yes		
9	Cyclic synchronous velocity mode	csv	Yes		
10	Cyclic synchronous torque mode	cst	Yes		

7.3.6 Servo various status list

Address	Function	Unit	Note
0x6060	Operation mode display	-	
0x6063	Encoder position	Code disc resolution	
0x6064	Encoder position	Code disc resolution	
0x606C	Motor speed	1/10000rpm	
0x6071	Torque command	Tn*0.01	
0x6077	Current torque	Tn*0.01	
0x6078	Current Current	0.1A	
0x607A	Location commands	Code disc resolution	
0x60FF	Speed command	1/10000rpm	
0x607C	Return to zero bias	Code disc resolution	
0x6098	Back to zero mode	1-14	

Chapter 7 EtherCAT Communication Functions

0x6099	Return to zero speed	1/10000rpm	
0x609A	Return to zero ac/deceleration time	0.1ms	
0x603F	Servo alarm code	-	

7.3.7 Various operating modes of the servo

7.3.7.1 CSP Mode

CSP (Cyclic Synchronous Position Mode), its motion trajectory is calculated by the host computer, and periodically sends the target position to the slave station.

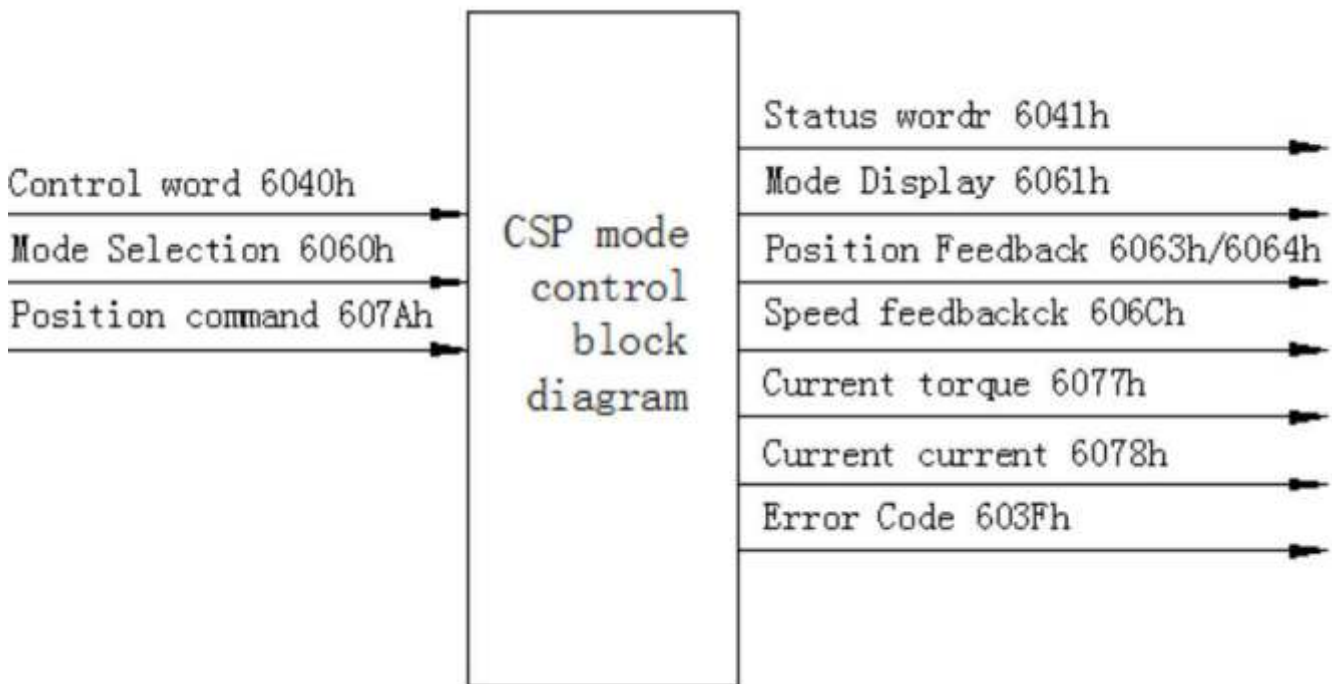

1) CSP mode associated object (setting class)

index	sub-in dex	Name	Unit	scope	type of data	accessib ility	PDO
-------	------------	------	------	-------	--------------	----------------	-----

Chapter 7 EtherCAT Communication Functions

6040h	00h	control word	-	0-65535	U16	RW	RxPDO
6060h	00h	operating mode	-	0-65535	U16	RW	RxPDO
607Ah	00h	target location	Code wheel resolution	-2147483648~ 2147483647	I32	RW	RxPDO

Note: ① For the use of control word 6040h, please refer to Chapter 7.3.2

② For the use of operating mode 6060h, please refer to Chapter 7.3.4

2) CSP mode associated object (monitoring class)

index	sub-in dex	Name	Unit	scope	type of data	accessib ility	PDO
6041h	00h	status word	-	0-65535	U16	RO	RxPDO
6061h	00h	Current operating mode display	-	0-65535	U16	RO	RxPDO
6063h	00h	Encoder position feedback	Code wheel resolution	-2147483648~ 2147483647	I32	RO	RxPDO
6064h	00h	Encoder position feedback	Code wheel resolution	-2147483648~ 2147483647	I32	RO	RxPDO
606Ch	00h	Motor Speed Feedback	1/10000rpm	-2147483648~ 2147483647	I32	RO	RxPDO
6077h	00h	current torque	0.01NM	-32768~32767	I16	RO	RxPDO
6078h	00h	current current	0.1A	0-65535	U16	RO	RxPDO

Note: ①For the use of control word 6041h, please refer to Chapter 7.3.3

②For the use of operating mode 6061h, please refer to Chapter 7.3.5

3) CSP mode association object (common parameter class)

index	sub-in dex	Name	Unit	scope	type of data	accessib ility	PDO
2005h	00h	Driver Control Mode	-	0-7	U16	RW	NO
2006h	00h	Position proportional gain	-	0-10000	U16	RW	NO
2018h	00h	Speed loop	Hz	5-2000	U16	RW	NO

Chapter 7 EtherCAT Communication Functions

		proportional gain					
2019h	00h	Speed loop integral time constant	ms	1-1000	U16	RW	NO
2044h	00h	Current loop proportional gain	Hz	1-500	U16	RW	NO
2045h	00h	Current loop integral time constant	ms	1-10000	U16	RW	NO
2061h	00h	Motor inertia ratio	-	1-32767	U16	RW	NO
2062h	00h	Motor rated torque	0.1Nm	1-1000	U16	RW	NO
2063h	00h	Motor rated speed	rpm	0-6000	U16	RW	NO
2065h	00h	Motor rated current	0.1A	1-500	U16	RW	NO
2087h	00h	Encoder bits	-	17 或 23	U16	RW	NO
2093h	00h	Number of motor pole pairs	-	4 或 5 (Please do not modify)	U16	RW	NO

7.3.7.2 CSV Mode

CSV (Cyclic Synchronous Velocity Mode) The motor runs at a constant speed through the periodic given speed of the host computer.

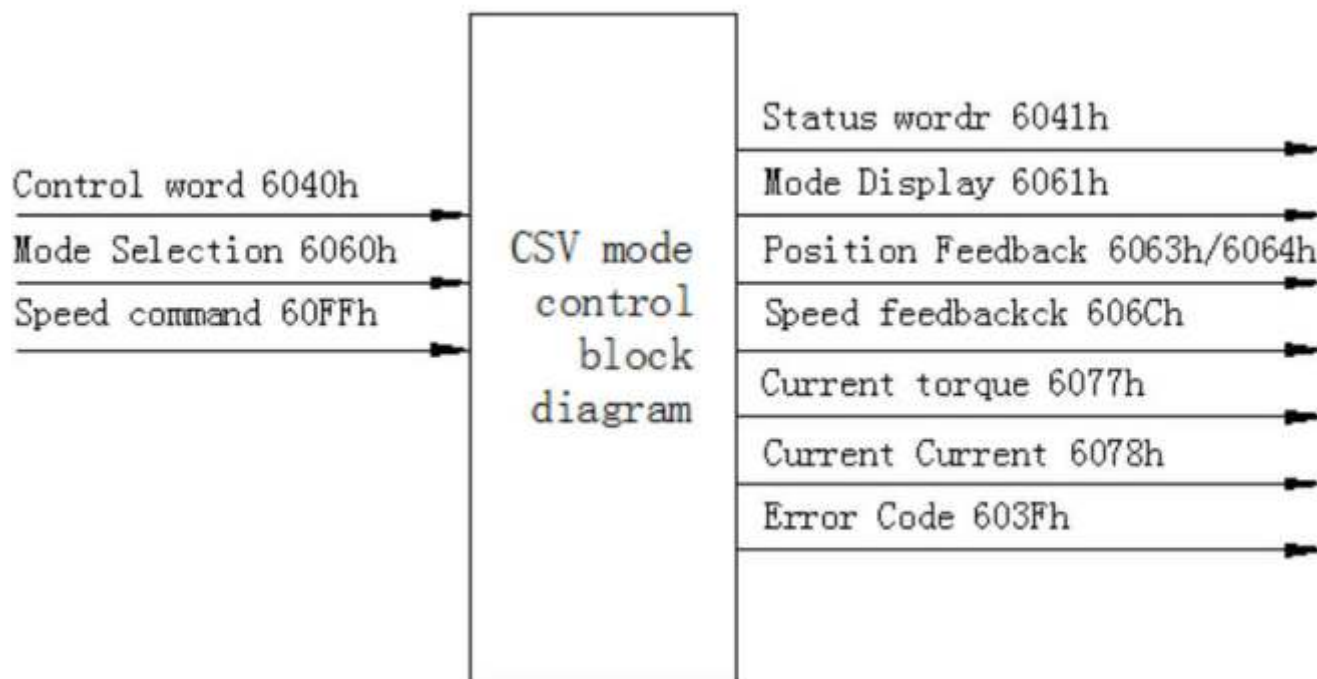

1) CSV schema associated object (setting class)

index	sub-index	Name	Unit	scope	type of data	accessibility	PDO
6040h	00h	control word	-	0-65535	U16	RW	RxPDO
6060h	00h	operating mode	-	0-65535	U16	RW	RxPDO
60FFh	00h	speed given	0.0001rpm	-2147483648~ 2147483647	I32	RW	RxPDO

Note: ①For the use of control word 6040h, please refer to Chapter 7.3.2

②For the use of operation mode 6060h, please refer to chapter 7.3.4

2) CSV mode associated object (monitoring class)

index	sub-index	Name	Unit	scope	type of data	accessibility	PDO
6041h	00h	status word	-	0-65535	U16	RO	RxPDO
6061h	00h	Current operating	-	0-65535	U16	RO	RxPDO

Chapter 7 EtherCAT Communication Functions

		mode display					
606Ch	00h	Motor Speed Feedback	0.0001rpm	-2147483648~ 2147483647	I32	RO	RxPDO
6077h	00h	current torque	0.01NM	-32768~32767	I16	RO	RxPDO
6078h	00h	current current	0.1A	0-65535	U16	RO	RxPDO

Note: ①For the use of control word 6041h, please refer to Chapter 7.3.3

②For the use of operating mode 6061h, please refer to Chapter 7.3.5

3) CSV mode associated object (common parameter class)

index	sub-index	Name	Unit	scope	type of data	accessibility	PDO
2005h	00h	Driver Control Mode	-	0-7	U16	RW	NO
2018h	00h	Speed loop proportional gain	Hz	5-2000	U16	RW	NO
2019h	00h	Speed loop integral time constant	ms	1-1000	U16	RW	NO
2044h	00h	Current loop proportional gain	Hz	1-500	U16	RW	NO
2045h	00h	Current loop integral time constant	ms	1-10000	U16	RW	NO
2061h	00h	Motor inertia ratio	-	1-32767	U16	RW	NO
2062h	00h	Motor rated torque	0.1Nm	1-1000	U16	RW	NO
2063h	00h	Motor rated speed	r/min	0-6000	U16	RW	NO
2065h	00h	Motor rated current	0.1A	1-500	U16	RW	NO
2087h	00h	Encoder bits	-	17 或 23	U16	RW	NO
2093h	00h	Number of motor pole pairs	-	4 或 5 (Please do not modify)	U16	RW	NO

7.3.7.3 CST mode

CST (Cycle Synchronous Torque Mode) makes the motor run with a constant torque through the periodic given torque of the upper computer.

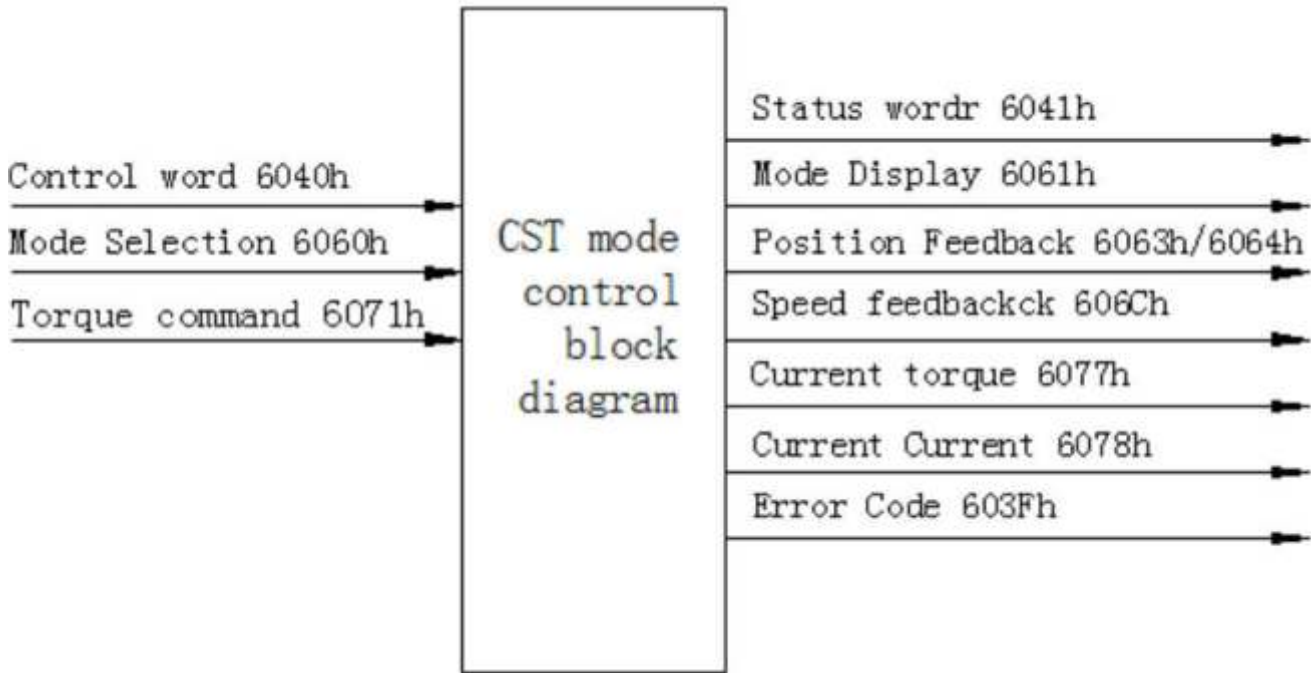

1) CST mode associated object (setting class)

index	sub-index	Name	Unit	scope	type of data	accessibility	PDO
6040h	00h	control word	-	0-65535	U16	RW	RxPDO
6060h	00h	operating mode	-	0-65535	U16	RW	RxPDO
6071h	00h	Torque given	0.01NM	-32768~32767	I16	RW	RxPDO

Note: ①For the use of control word 6040h, please refer to Chapter 7.3.2

②For the use of operation mode 6060h, please refer to chapter 7.3.4

2) CST mode associated object (monitoring class)

index	sub-index	Name	Unit	scope	type of data	accessibility	PDO
-------	-----------	------	------	-------	--------------	---------------	-----

Chapter 7 EtherCAT Communication Functions

6041h	00h	status word	-	0-65535	U16	RO	RxPDO
6061h	00h	Current operating mode display	-	0-65535	U16	RO	RxPDO
606Ch	00h	Motor Speed Feedback	0.0001* r/min	-2147483648~ 2147483647	I32	RO	RxPDO
6077h	00h	current torque	0.01NM	-32768~32767	I16	RO	RxPDO
6078h	00h	current current	0.1A	0-65535	U16	RO	RxPDO

Note: ①For the use of control word 6041h, please refer to Chapter 7.3.3

②For the use of operating mode 6061h, please refer to Chapter 7.3.5

3) CST mode associated object (common parameter class)

index	sub-index	Name	Unit	scope	type of data	accessibility	PDO
2005h	00h	Driver Control Mode	-	0-7	U16	RW	NO
2018h	00h	Speed loop proportional gain	Hz	5-2000	U16	RW	NO
2019h	00h	Speed loop integral time constant	ms	1-1000	U16	RW	NO
2044h	00h	Current loop proportional gain	Hz	1-500	U16	RW	NO
2045h	00h	Current loop integral time constant	ms	1-10000	U16	RW	NO
2061h	00h	Motor inertia ratio	-	1-32767	U16	RW	NO
2062h	00h	Motor rated torque	0.1Nm	1-1000	U16	RW	NO
2063h	00h	Motor rated speed	r/min	0-6000	U16	RW	NO
2065h	00h	Motor rated current	0.1A	1-500	U16	RW	NO
2087h	00h	Encoder bits	-	17 23	U16	RW	NO
2093h	00h	Number of motor pole pairs	-	4 5 (Please do not modify)	U16	RW	NO

7.3.7.4 PP Mode

PP (profile position mode) is a position control mode that specifies the target position, target speed, etc., and performs trajectory planning inside the servo drive.

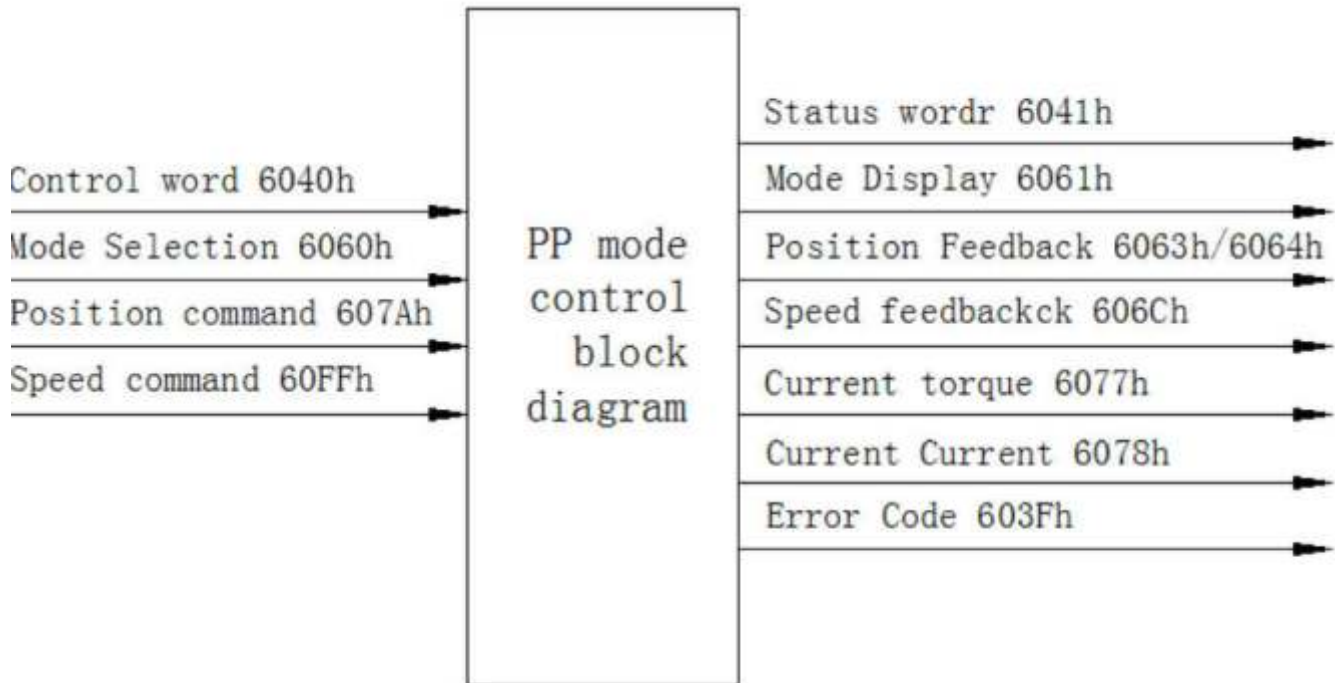

1) PP mode associated object (setting class)

index	sub-index	Name	Unit	scope	type of data	accessibility	PDO
6040h	00h	control word	-	0-65535	U16	RW	RxPDO
6060h	00h	operating mode	-	0-65535	U16	RW	RxPDO
607Ah	00h	target location	Code wheel resolution	-2147483648~ 2147483647	I32	RW	RxPDO
60FFh	00h	target speed	0.0001r/m	-2147483648~ 2147483647	I32	RW	RxPDO

Note: ①For the use of control word 6040h, please refer to Chapter 7.3.2

②For the use of operation mode 6060h, please refer to chapter 7.3.4

2) PP mode associated object (monitoring class)

index	sub-index	Name	Unit	scope	type of data	accessibility	PDO
6041h	00h	status word	-	0-65535	U16	RO	RxPDO
6061h	00h	Current operating mode display	-	0-65535	U16	RO	RxPDO
6063h	00h	Encoder position feedback		-2147483648~ 2147483647	I32	RO	RxPDO
6064h	00h	Encoder position feedback		-2147483648~ 2147483647	I32	RO	RxPDO
606Ch	00h	Motor Speed Feedback	1/10000rpm	-2147483648~ 2147483647	I32	RO	RxPDO
6077h	00h	current torque	0.01NM	-32768~32767	I16	RO	RxPDO
6078h	00h	current current	0.1A	0-65535	U16	RO	RxPDO

Note: ①For the use of control word 6041h, please refer to Chapter 7.3.3

②For the use of operating mode 6061h, please refer to Chapter 7.3.5

3) PP mode associated object (common parameter class)

index	sub-index	Name	Unit	scope	type of data	accessibility	PDO
2005h	00h	Driver Control Mode	-	0-7	U16	RW	NO
2006h	00h	Position proportional gain	-	0-10000	U16	RW	NO
2018h	00h	Speed loop proportional gain	Hz	5-2000	U16	RW	NO
2019h	00h	Speed loop integral time constant	ms	1-1000	U16	RW	NO
2044h	00h	Current loop proportional gain	Hz	1-500	U16	RW	NO

Chapter 7 EtherCAT Communication Functions

2045h	00h	Current loop integral time constant	ms	1-10000	U16	RW	NO
2061h	00h	Motor inertia ratio	-	1-32767	U16	RW	NO
2062h	00h	Motor rated torque	0.1Nm	1-1000	U16	RW	NO
2063h	00h	Motor rated speed	r/min	0-6000	U16	RW	NO
2065h	00h	Motor rated current	0.1A	1-500	U16	RW	NO
2087h	00h	Encoder bits	-	17 23	U16	RW	NO
2093h	00h	Number of motor pole pairs	-	4 5 (Please do not modify)	U16	RW	NO

7.3.7.5 PV Mode

PV (profile speed mode), is a speed control mode that specifies the target speed, etc., and performs trajectory planning inside the servo drive.

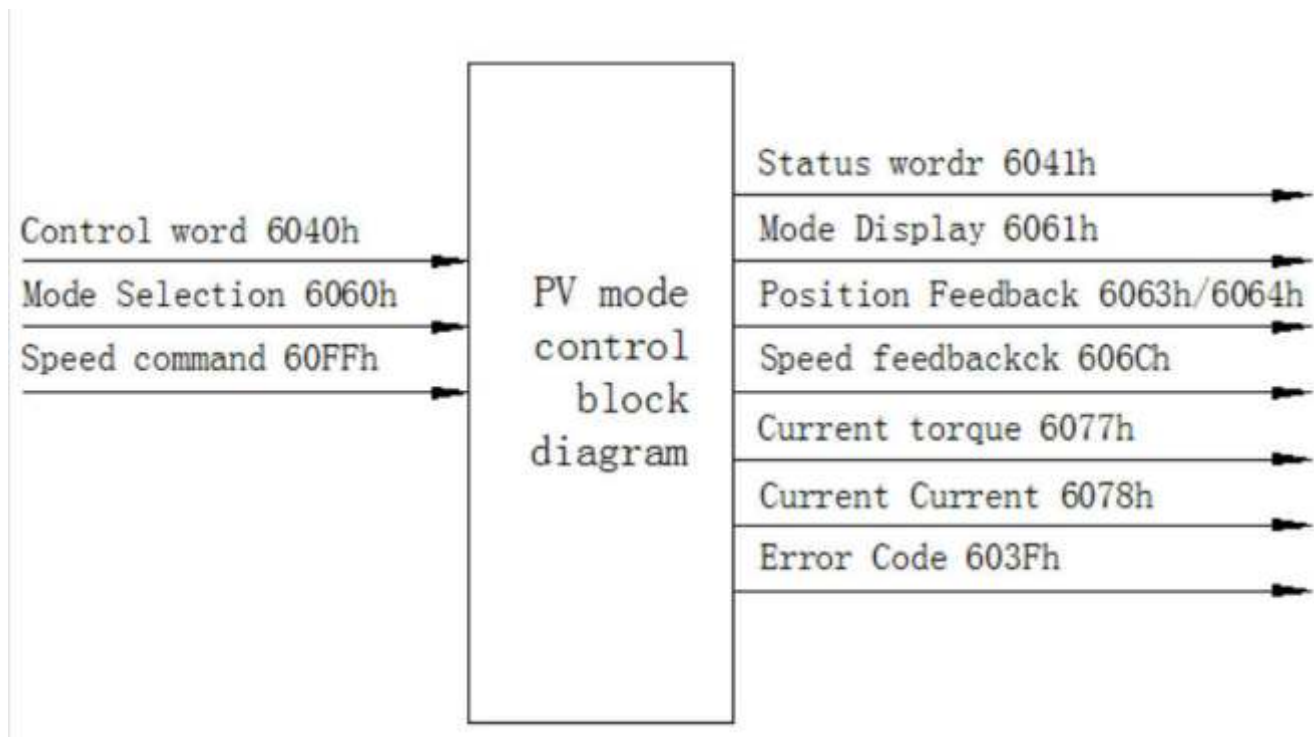

1) PV mode associated object (setting class)

index	sub-index	Name	Unit	scope	type of data	accessibility	PDO
6040h	00h	control word	-	0-65535	U16	RW	RxPDO
6060h	00h	operating mode	-	0-65535	U16	RW	RxPDO
60FFh	00h	speed given	0.0001rpm	-2147483648~ 2147483647	I32	RW	RxPDO

Note: ①For the use of control word 6040h, please refer to Chapter 7.3.2

②For the use of operation mode 6060h, please refer to chapter 7.3.4

2) PV mode associated object (monitoring class)

index	sub-index	Name	Unit	scope	type of data	accessibility	PDO
6041h	00h	status word	-	0-65535	U16	RO	RxPDO
6061h	00h	Current operating mode display	-	0-65535	U16	RO	RxPDO
606Ch	00h	Motor Speed Feedback	0.0001rpm	-2147483648~ 2147483647	I32	RO	RxPDO
6077h	00h	current torque	0.01NM	-32768~32767	I16	RO	RxPDO
6078h	00h	current current	0.1A	0-65535	U16	RO	RxPDO

Note: ①For the use of control word 6041h, please refer to Chapter 7.3.3

②For the use of operating mode 6061h, please refer to Chapter 7.3.5

3) PV mode associated object (common parameter class)

index	sub-index	Name	Unit	scope	type of data	accessibility	PDO
2005h	00h	Driver Control Mode	-	0-7	U16	RW	NO
2018h	00h	Speed loop	Hz	5-2000	U16	RW	NO

Chapter 7 EtherCAT Communication Functions

		proportional gain					
2019h	00h	Speed loop integral time constant	ms	1-1000	U16	RW	NO
2044h	00h	Current loop proportional gain	Hz	1-500	U16	RW	NO
2045h	00h	Current loop integral time constant	ms	1-10000	U16	RW	NO
2061h	00h	Motor inertia ratio	-	1-32767	U16	RW	NO
2062h	00h	Motor rated torque	0.1Nm	1-1000	U16	RW	NO
2063h	00h	Motor rated speed	r/min	0-6000	U16	RW	NO
2065h	00h	Motor rated current	0.1A	1-500	U16	RW	NO
2087h	00h	Encoder bits	-	17 或 23	U16	RW	NO
2093h	00h	Number of motor pole pairs	-	4 或 5 (Please do not modify)	U16	RW	NO

7.3.7.6 HM Mode

HM mode (that is, homing mode), used for initialization of the position of the slave station.

Origin return method: specify the movement speed, and generate instructions inside the servo drive to execute the position control mode of the origin return action.

Chapter 7 EtherCAT Communication Functions

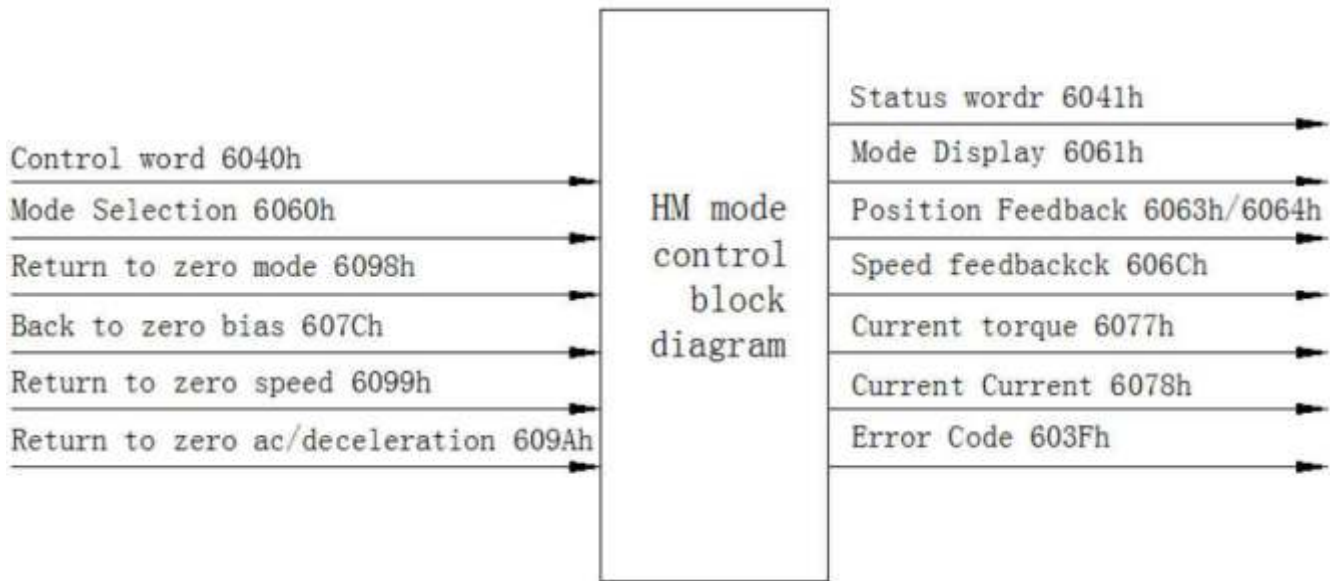

1) HM mode associated object (setting class)

index	sub-index	Name	Unit	scope	type of data	accessibility	PDO
6040h	00h	control word	-	0-65535	U16	RW	RxPDO
6060h	00h	operating mode	-	0-65535	U16	RW	RxPDO
607Ch	00h	Back to zero bias	Code wheel resolution	-2147483648~ 2147483647	I32	RW	RxPDO
6098h	00h	Return to zero mode	-	1-14	U8	RW	RxPDO
6099h	01h	Back to zero high speed	0.0001r/m	-2147483648~ 2147483647	I32	RW	RxPDO
	02h	Return to zero low speed	0.0001r/m		I32	RW	RxPDO
609Ah	00h	Return to zero ac/deceleration time	0.1ms	0~4294967295	UI32	RW	RxPDO

Note: ①For the use of control word 6040h, please refer to Chapter 7.3.2

②For the use of operation mode 6060h, please refer to chapter 7.3.4

Chapter 7 EtherCAT Communication Functions

		time constant					
2044h	00h	Current loop proportional gain	Hz	1-500	U16	RW	NO
2045h	00h	Current loop integral time constant	ms	1-10000	U16	RW	NO
2061h	00h	Motor inertia ratio	-	1-32767	U16	RW	NO
2062h	00h	Motor rated torque	0.1Nm	1-1000	U16	RW	NO
2063h	00h	Motor rated speed	r/min	0-6000	U16	RW	NO
2065h	00h	Motor rated current	0.1A	1-500	U16	RW	NO
2087h	00h	Encoder bits	-	17 23	U16	RW	NO
2093h	00h	Number of motor pole pairs	-	4 5 (Please do not modify)	U16	RW	NO
2143h	00h	Return to zero mode	-	1-14	U8	RW	NO
2144h	00h	Back to zero high speed	0.0001r/m	0~3000 r/min	I32	RW	NO
2145h	00h	Return to zero low speed	0.0001r/m	0~100 r/min	I32	RW	NO
2146h	00h	Return to zero ac/deceleration time	0.1ms	0-30000	UI32	RW	NO
2147h	00h	Back to zero bias low	Code wheel resolution	-2147483648~ 2147483647	I32	RW	NO
2148h	00h	Back to zero bias high	Code wheel resolution	-2147483648~ 2147483647	I32	RW	NO
2149h	00h	Recognition range of completion of zero return	Code wheel resolution	-2147483648~ 2147483647	I32	RW	NO

4) Introduction of HM zero return mode

Chapter 7 EtherCAT Communication Functions

Control word 6040h	Instructions
Bit4	Zero return start trigger (0→1)

Status word 6041h	Instructions
Bit15	Return to zero complete signal (0→1)

2) HM mode associated object (monitoring class)

index	sub-index	Name	Unit	scope	type of data	accessibility	PDO
6041h	00h	Status word	-	0-65535	U16	RO	RxPDO
6061h	00h	Current operating mode display	-	0-65535	U16	RO	RxPDO
6063h	00h	Encoder position feedback	Code wheel resolution	-2147483648~ 2147483647	I32	RO	RxPDO
6064h	00h	Encoder position feedback	Code wheel resolution	-2147483648~ 2147483647	I32	RO	RxPDO
606Ch	00h	Motor Speed Feedback	1/10000rpm	-2147483648~ 2147483647	I32	RO	RxPDO

Note: ①For the use of control word 6041h, please refer to Chapter 7.3.3

②For the use of operating mode 6061h, please refer to Chapter 7.3.5

3) HM mode associated object (common parameter class)

index	sub-index	Name	Unit	scope	type of data	accessibility	PDO
2005h	00h	Driver Control Mode	-	0-7	U16	RW	NO
2006h	00h	Position proportional gain	-	0-10000	U16	RW	NO
2018h	00h	Speed loop proportional gain	Hz	5-2000	U16	RW	NO
2019h	00h	Speed loop integral	ms	1-1000	U16	RW	NO

HM supports 14 back-to-origin modes, which are described in detail below :

6098h=1

The driver first moves to the negative direction quickly, and then decelerates to stop when it reaches the negative limit switch, and then the driver returns slowly to find the target zero position.

6098h=2

The driver first moves to the positive direction quickly, and then decelerates to stop when it reaches the positive limit switch, and then the driver returns slowly to find the target zero position.

6098h=3 OR 4

When starting, if the origin switch is low, the motor will run forward to find the switch position, otherwise it will run negatively to find the switch position. After finding the switch, mode 3 runs the zero point in the negative direction, and mode 4 runs the zero point in the positive direction

6098h=5 OR 6

If the origin switch is low at startup, the motor will run negatively to find the switch position, otherwise it will run forward to find the switch position. After finding the switch, run the zero point forward in mode 5, and run the zero point in negative direction in mode 6.

6098h=7 OR 14

At the beginning, if the origin switch signal is low, modes 7 to 10 run in positive direction, and modes 11 to 14 run in negative direction. If the switch signal is valid at the beginning, the running direction depends on whether the set origin is on the left edge or the right edge of the switch signal. If the positive limit switch is encountered during forward running, it will turn back to find the origin switch. After finding the required edge signal of the origin switch, find the zero point according to the set direction.

7.3.8 Probe Function Status Bits 0x60B9

The probe function does not need to be set, and all work by default. If the value is not read in time, it will be overwritten. If the probe count changes, it means that a probe event has occurred. The initial value is meaningless

- bit0~1 Probe 1 rising edge count
- bit2~3 Probe 1 falling edge counting
- bit4~5 Probe 2 rising edge count
- bit6~7 Probe 2 falling edge counting
- bit8~9 Probe 3 rising edge count
- bit10~11 Probe 3 falling edge counting
- bit12 Probe 1 level
- bit13 Probe 2 level
- bit14 Probe 3 level

address	Function	Unit	Note
0x60BA	Rising edge position of probe 1 (code wheel position)	Code wheel resolution	
0x60BB	Probe 1 falling edge position	Code wheel resolution	
0x60BC	Probe 2 rising edge position	Code wheel resolution	

Chapter 7 EtherCAT Communication Functions

0x60BD	Probe 2 falling edge position	Code wheel resolution	
0x60BE	Probe 3 rising edge position	Code wheel resolution	
0x60BF	Probe 3 falling edge position	Code wheel resolution	

7.3.9 Parameter transfer function

The parameter transmission address starts from 0x2001, and there are 140 parameters in total.

Chapter 8 Alarm and Handling

If the server fails during use, the display will display: Al—xx, if there are multiple alarms at the same time, the alarm code will be displayed in circles. Please operate according to the content of this chapter; after troubleshooting the corresponding faults, it can be put into use again.

8.1 Alarm list

alarm code	Alarm name	Alarm reason
AL-0	normal	
AL-1	Over speed	Servo motor speed exceeds the set value
AL-2	Main circuit overvoltage	The main circuit voltage is too high
AL-3	Main circuit undervoltage	The main circuit voltage is too low
AL-4	The location is out of tolerance	The motor deviation exceeds the set value of parameter Pn13
AL-6	Velocity Amplifier Saturation	Speed regulator saturates for a long time
AL-7	Forward and reverse drive prohibited	Drive prohibition parameter takes effect
AL-8	Position deviation counter overflow	The input command frequency is too high, or the motor load is too large, etc.
AL-9	Encoder exception	There is a disconnection or short circuit in the encoder

Chapter 8 Alarm and Handling

AL-11	Module alarm	The temperature is too high or the module is abnormal, etc.
AL-12	Overcurrent	The current exceeds the allowable value
AL-13	overload	Mechanical stuck or long-term operation exceeding the rated load
AL-14	Abnormal braking	Braking resistor power is too small or braking failure
AL-16	motor thermal overload	Long-term operation exceeding the rated load
AL-20	EPROM error	Servo internal EEPROM read and write exception
AL-24	FPGA communication is abnormal	FPGA communication is abnormal
AL-25	Code disc CRC check error	Drive and encoder mismatch or interference
AL-45	ADC error	ADC error
AL-46	Code wheel battery low	Code disc battery voltage is lower than 3.1V
AL-47	Code wheel battery no voltage	No battery installed or battery failure
AL-48	The number of turns of the code wheel is wrong during operation	The code disc is broken or the voltage of the code disc battery is low

8.2 Alarm handling method

alarm code	Alarm name	Alarm reason	handling method
AL-1	Over speed	Input command pulse speed is too high	Correctly set the input command pulse
		Encoder zero error;	Ask the manufacturer to reset the zero point of the encoder
		Motor U, V, W leads are wrongly connected	Confirm wiring phase sequence
AL-2	Main circuit overvoltage	Input L1 L2 L3 power supply voltage is higher than AC260V	reduce power supply voltage
		Brake circuit capacity is not enough (Mostly occur in occasions where rapid start and stop are frequent and the load inertia is relatively large)	<ol style="list-style-type: none"> 1. Extend the acceleration and deceleration time of the control system 2. Contact the manufacturer to increase the braking resistor capacity
AL-3	Main circuit undervoltage	Input L1 L2 L3 power supply voltage is lower than AC170V	The external power supply is out of phase and the voltage is unstable
		The detection circuit is damaged, and the alarm will be reported immediately when the power is turned on.	Replace the servo drive
AL-4	Main circuit undervoltage	Execute the operation, the motor does not rotate any angle, immediately alarm	<ol style="list-style-type: none"> 1. Confirm whether the phase sequence of the UVW line of the motor is correct 2. Confirm whether the input pulse frequency is too high
		Alarm during rotation (command speed is too high)	Confirm input pulse frequency and width
		Alarm during rotation (out-of-tolerance detection range is too small)	Set parameter Pn13 larger
		Alarm during rotation (position proportional gain is too small)	Increase the setting value of position gain Pn5
		Alarm during rotation (insufficient torque)	Replace the high-power servo drive motor

Chapter 8 Alarm and Handling

AL-6	Velocity Amplifier Saturation	The motor is mechanically stuck	Check the mechanical part of the load
		Too much load	1. Reduce the load 2. Replace the driver and motor with higher power
AL-9	Encoder failure	Encoder wiring error or disconnection	Check or replace encoder cable
		caused by on-site interference	Rearrange electrical cabinets away from sources of interference
		Encoder cable is too long, resulting in low encoder power supply voltage	Shorten the cable or increase the number of cores
AL-11	Overcurrent at power-up	poor grounding	properly grounded
		Motor insulation damage or motor short circuit	Replace the motor after measuring the insulation with a megohmmeter
		The power line is damaged or short-circuited to the casing	Replace the motor power cable
		After unplugging the power line and re-powering, the alarm still occurs	replace drive
	Overcurrent occurs during operation	Servo matching motor parameters do not match	Recheck the set motor ID number
		Acceleration and deceleration time is too short	Increase the acceleration and deceleration time of the host computer or increase Pn29 and Pn30 to reduce the current impact
Current shock		Decrease parameter Pn43 Pn5	
AL-12	Overcurrent	Damaged motor insulation	replace the motor
		poor grounding	properly grounded
		After unplugging the power line and re-powering, the alarm still occurs	Replace the servo drive
AL-13	overload	Mechanism is stuck or the load exceeds the limit value	1. Mechanical stuck or high resistance 2. The motor type selection is unreasonable, replace the drive and motor with a higher power
AL-14	Abnormal braking	Brake circuit capacity is not enough	1. Add an external braking unit 2. Increase the ac/deceleration time constant 3. Replace the servo and motor with higher power
		The main circuit power is too high	Check AC input power

Chapter 8 Alarm and Handling

AL-16	motor thermal overload	The motor works for a long time exceeding the rated load	1. Exclude the cause of large mechanical resistance 2. Replace the high torque motor
AL-20	EPROM error	Abnormal reading and writing of EPROM inside the servo	Replace the servo drive
AL-24	FPGA error	FPGA communication is abnormal	Replace the servo drive
AL-25	Code disc CRC check error	CRC check error	1. Check or replace the encoder cable 2. Eliminate external interference, optimize the layout of the electrical cabinet, keep away from interference sources, and properly ground the encoder line 3. Encoder casing, motor casing and driver metal casing are all connected to the FG end of the machine 4. Replace the motor 5. Replace the drive
AL-45	ADC error	ADC error	Replace the servo drive
AL-46	Encoder battery low	Encoder battery voltage is lower than 3.1V Remind user to replace battery	If this alarm appear when the device is turned on, and it cannot be enabled. If you want to continue using it, you can set Pn87=0 to use it. If it occurs during operation, it will only alarm but not enable, and will not affect the use. This alarm will be cleared automatically after replacing the battery
AL-47	Code wheel battery no voltage	Indicates that the battery is dead, and the lap data is incorrect when the power is turned on.	You need to run the code disc alarm clearing program to clear . Pn87=1 does not check this alarm.
AL-48	Absolute value code disc number error	The code wheel is broken or the battery voltage of the code wheel is low	It is necessary to run the code disc alarm clearing program to clear or replace the code disc.

Note: AL-47 AL-48 these two kinds of alarms may appear only when they are equipped with multi-turn absolute encoders. For the sake of safety, if the above two kinds of alarms appear, power on again, and the alarms cannot be eliminated directly. Need to do the following:

Ways to clear AL47: Pn4=4 Pn95=1 Pn0=789 In the F4 interface, press and hold the Enter key for 5 seconds, then power on again. If invalid, replace the motor encoder.

Ways to clear AL48: Pn4=4 Pn95=1 Pn0=788 In the F4 interface, press and hold the Enter key for 5 seconds, then power on again. If invalid, replace the motor encoder.

Special note: If the servo driver displays an alarm, but after power on again, the alarm disappears. It is generally considered to be caused by problems with components other than the servo drive or improper parameter adjustment. Please check the peripheral components of the servo. Such as: power supply voltage, controller, mechanical load, motor, etc. If there is no problem in detecting peripheral components, please consult the manufacturer to adjust the parameters.

If the alarm cannot be eliminated after power on again, please replace the servo driver and observe again.