

SPECIFICATION SHEET
Bholanath

X AXIS POSITIONING TABLE
BHBS-XSLIDE-300-M

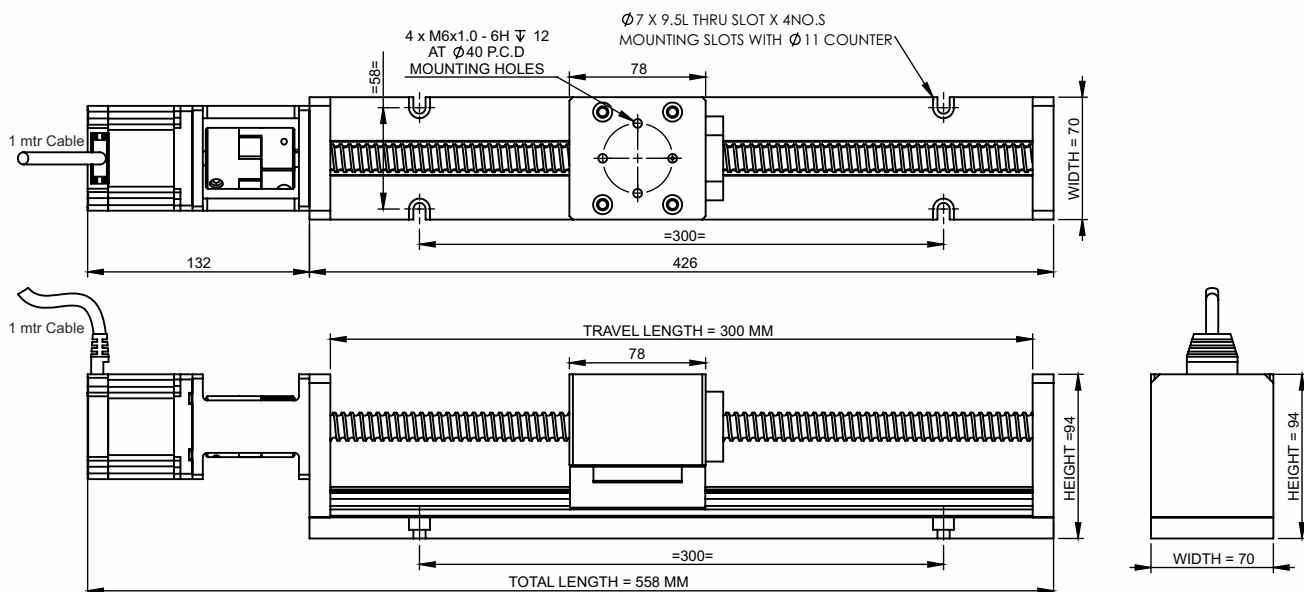

HIGH PRECISION X AXIS POSITIONING TABLE - LINEAR BALL SCREW SLIDES



TECHNICAL DATA

SPECIFICATION Model No		BHBS-XSLIDE-300-M
1	Maximum load carrying capacity(kg)	140
2	Permissible Feed Speed	0 to 90 mm/sec
3	Positioning Accuracy (mm)	≤ 0.02
4	Degree Of protection	IP 40
5	Total Weight of slide (KG)	9

Note:- The Load Calculation is Based On Horizontal Movement. For Vertical Movement Kindly Consider Safety Factor Of 0.6 And Motor With Brake.

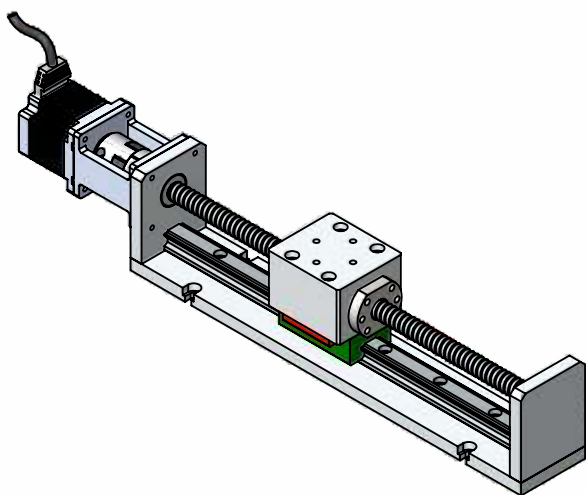
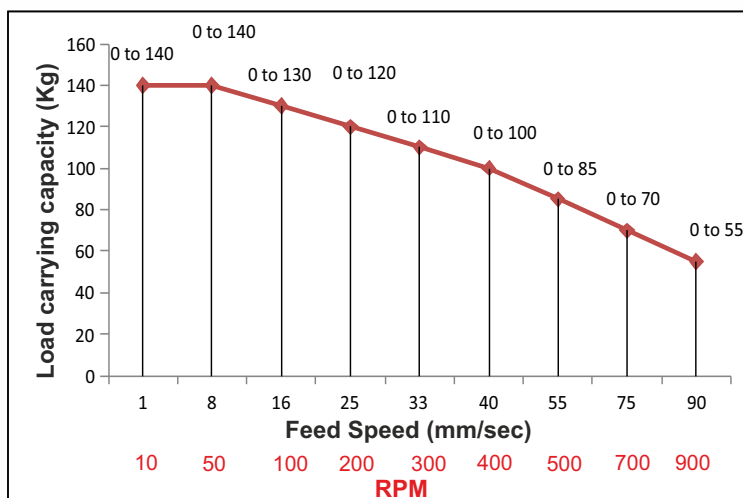

Bholanath Precision Engineering Pvt.Ltd.

11,Kembros Ind.Estate , Sonapur Lane , Bhandup (W),Mumbai - 400078.
Telefax/Phone : 25662856/25664338/67993260 Email : support@bholanath.in
Mobile No : 9920903825/9821671733/9930514603/9819515543/9323166582.