

SPECIFICATION SHEET
Bholanath

STEPPER MOTOR
BH42 SH 47 - 1504 BRK
HIGH TORQUE HYBRID

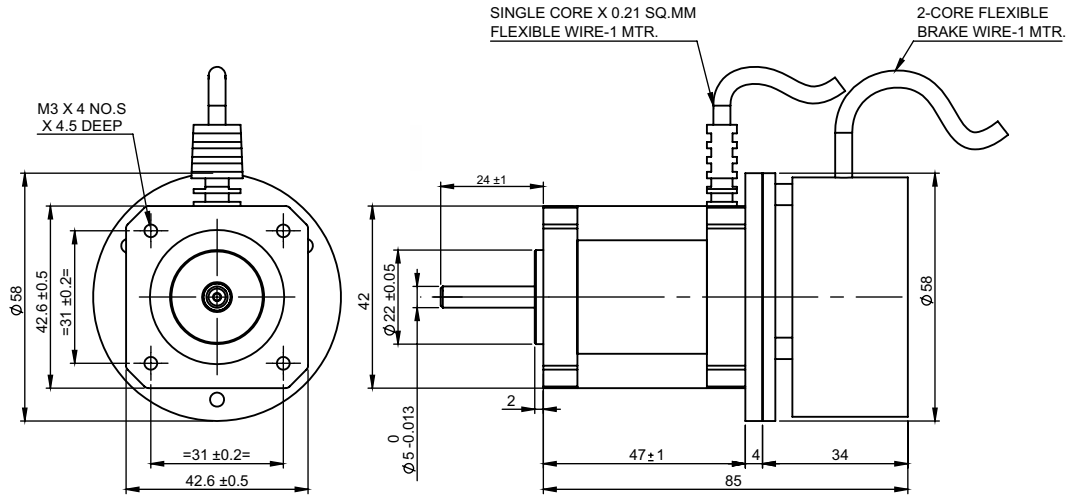
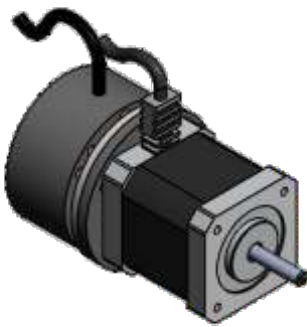

BRAKE DETAILS :
Torque : 1 Nm
Voltage : 24 V
Current at 20°C - 0.48 Amps
Power Consumption at 20°C : 9 Watts

TECHNICAL DATA

CHARACTERISTICS

- Step Angle - 1.8°
- Step Angle Accuracy - ± 3 Arc Minute
- Insulation Class - H
- Ambient Temperature - (- 20°C to + 50°C)
- Temperature Rise - 80°C Max. (Rated Current Phase 2 ON)
- Insulation Resistance 100 M Ohms Min. 500 VDC
- Dielectric Strength 500 VAC For One Minute
- Shaft Radial Play 0.02 Max. Play (450 G Load)
- Shaft Axial Play 0.08 Max. Play (450 G Load)
- Max.Radial Force 28 N (20MM From Front Flange)
- Max.Axial Force 10 N

SPECIFICATION

BH 42 SH 47- 1504 BRK

MODEL		Bipolar
1	Rated Voltage	V 4.2
2	Current / Phase	A 1.5
3	Resistance / Phase	± 10% Ω 2.8
4	Inductance / Phase	± 20% mH 5.7
5	Holding Torque	Nm 0.55
6	Rotor Inertia	G-CM ² 68
7	Weight	KG. 0.755
8	No of Lead	N° 4
9	Operating Voltage	VDC 12 - 24

Wiring Diagram

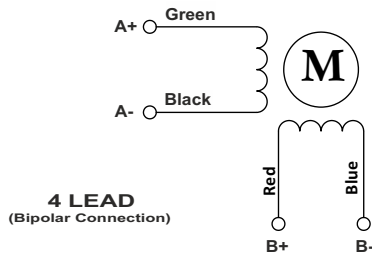

DRIVE SET

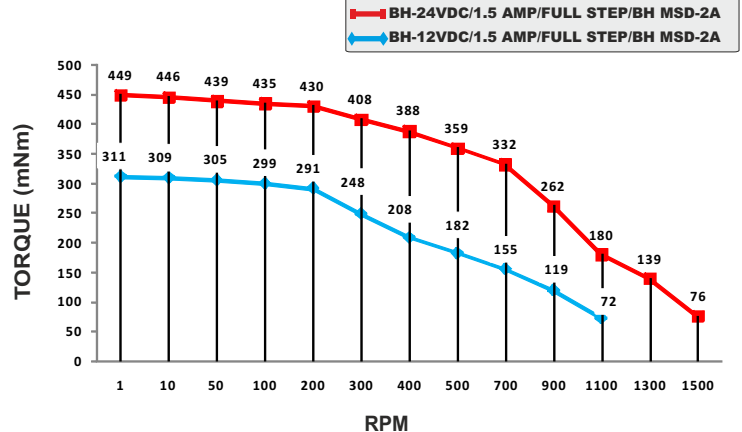

Bholanath Precision Engineering Pvt.Ltd.

11,Kembros Ind.Estate , Sonapur Lane , Bhandup (W),Mumbai - 400078.
Telefax/Phone : 25662856/25664338/67993260 Email : support@bholanath.in
Mobile No : 9920903825/9821671733/9930514603/9819515543/9323166582.