

**SPECIFICATION SHEET**  
**Bholanath**

**STEPPER MOTOR**  
**BH 57 SH 76-1006 A**  
**HIGH TORQUE HYBRID**

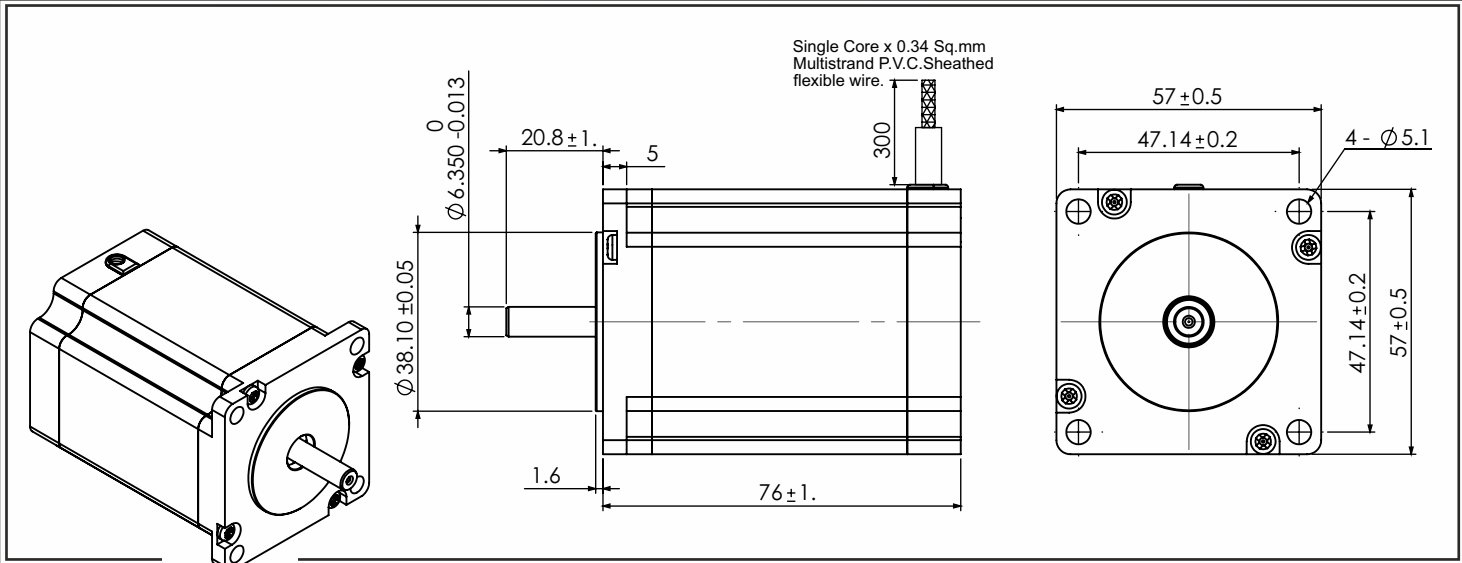

**TECHNICAL DATA**

**CHARACTERISTICS**

Step Angle - 1.8°
Step Angle Accuracy - ± 3 Arc Minute
Insulation Class - H
Ambient Temperature - - 20°C + 50°C
Temperature Rise - 80°C Max. ( Rated Current Phase 2 ON )
Insulation Resistance 100 M Ohms Min.500 VDC
Dielectric Strength 500 VAC For One Minute
Shaft Radial Play 0.02 Max. Play ( 450 G Load )
Shaft Axial Play 0.08 Max. Play ( 450 G Load )
Max.Radial Force 75 N ( 20MM From Front Flange )
Max.Axial Force 15 N

**SPECIFICATION**

BH57SH76 - 1006 A

	MODEL	Unipolar	
1	Rated Voltage	V	8.6
2	Current / Phase	A	1
3	Resistance / Phase	± 10% Ω	8.6
4	Inductance / Phase	± 20% mH	7.8
5	Holding Torque	Nm	1.35
6	Rotor Inertia	G-CM <sup>2</sup>	480
7	Weight	KG.	1.05
8	No of Lead	N <sup>0</sup>	6
9	Operating Voltage	VDC	24 - 37

**Wiring Diagram**

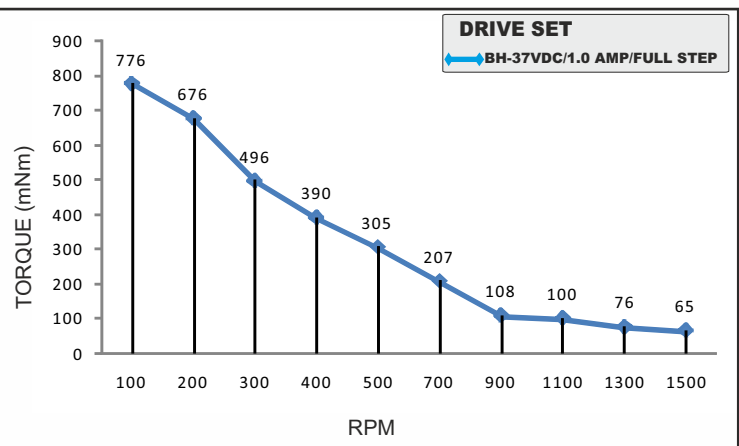
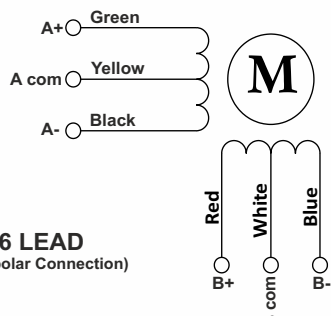

**MOTOR MODEL - BH57SH76-1006A**



**Bholanath Precision Engineering Pvt.Ltd.**

11,Kembros Ind.Estate , Sonapur Lane , Bhandup (W),Mumbai - 400078.  
Telefax/Phone : 25662856/25664338/67993260 Email : support@bholanath.in  
Mobile No : 9920903825/9821671733/9930514603/9819515543/9323166582.