

SPECIFICATION SHEET
Bholanath

STEPPER MOTOR
BH86 SH 80 - 5504AKS-IP65
HIGH TORQUE HYBRID

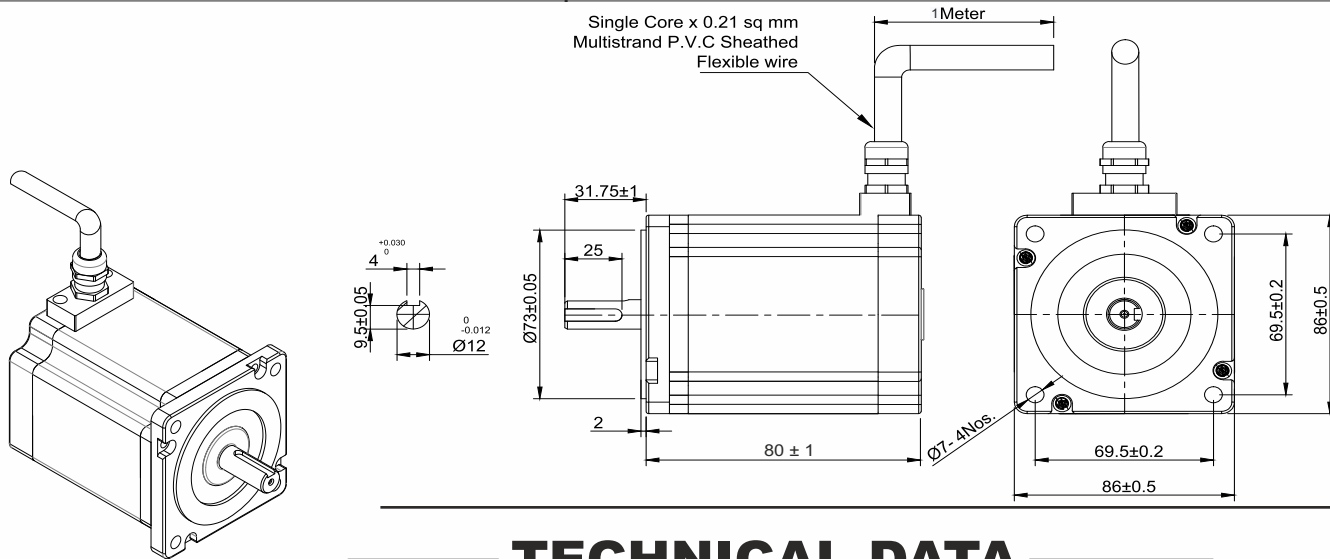

IP65 PROTECTION AGAINST CONTACT AND INFILTRATION OF WATER AND DIRT



TECHNICAL DATA

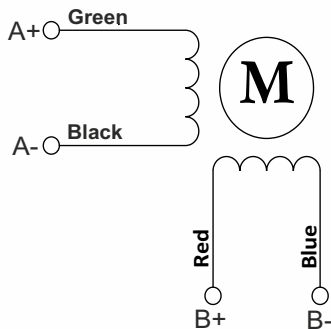

Wiring Diagram

SPECIFICATION BH86SH80 - 5504 AKS-IP65			
	MODEL		Bipolar
1	Rated Voltage	V	2.42
2	Current / Phase	A	5.5
3	Resistance / Phase	± 10% Ω	0.44
4	Inductance / Phase	± 20% mH	3.6
5	Holding Torque	Nm	5.09
6	Rotor Inertia	G-CM ²	1400
7	Weight	KG.	2.5
8	No of Lead	N ⁰	4
9	Operating Voltage	VDC	48 - 170
10	Operating Voltage	VAC	34 - 120

CHARACTERISTICS

- Step Angle - 1.8°
- Step Angle Accuracy - ± 3 Arc Minute
- Insulation Class - H
- Ambient Temperature - -20°C + 50°C
- Temperature Rise - 80°C Max. (Rated Current Phase 2 ON)
- Insulation Resistance 100 M Ohms Min.500 VDC
- Dielectric Strength 820 VAC For One Minute
- Shaft Radial Play 0.02 Max. Play (450 G Load)
- Shaft Axial Play 0.08 Max. Play (450 G Load)
- Max.Radial Force 220 N (20MM From Front Flange)
- Max.Axial Force 60 N

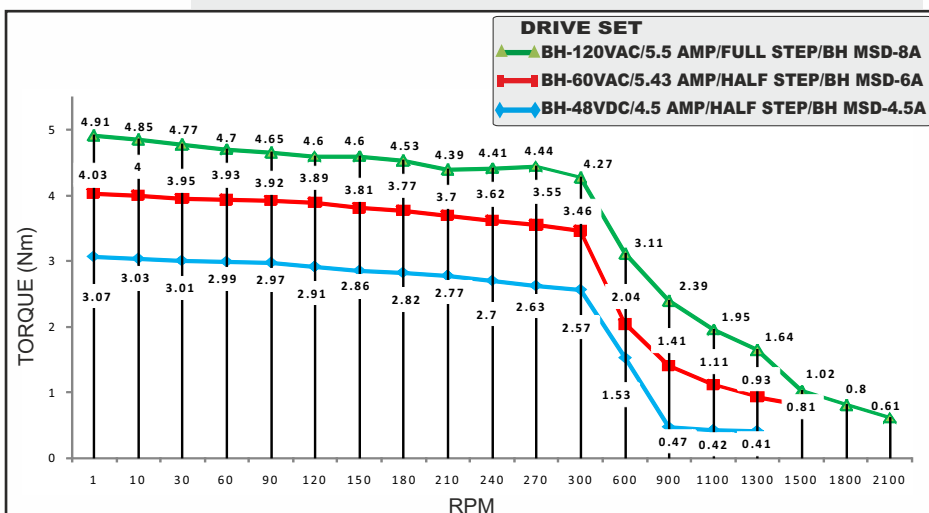

STEPPER MOTOR -BH86SH80-5504AKS-IP65



Bholanath Precision Engineering Pvt.Ltd.

11,Kembros Ind.Estate , Sonapur Lane , Bhandup (W),Mumbai - 400078.
Telefax/Phone : 25662856/25664338/67993260 Email : support@bholanath.in
Mobile No : 9920903825/9821671733/9930514603/9819515543/9323166582.