

SPECIFICATION SHEET
Bholanath

STEPPER MOTOR
BH42 SH 33-1334 A-CE
HIGH TORQUE HYBRID

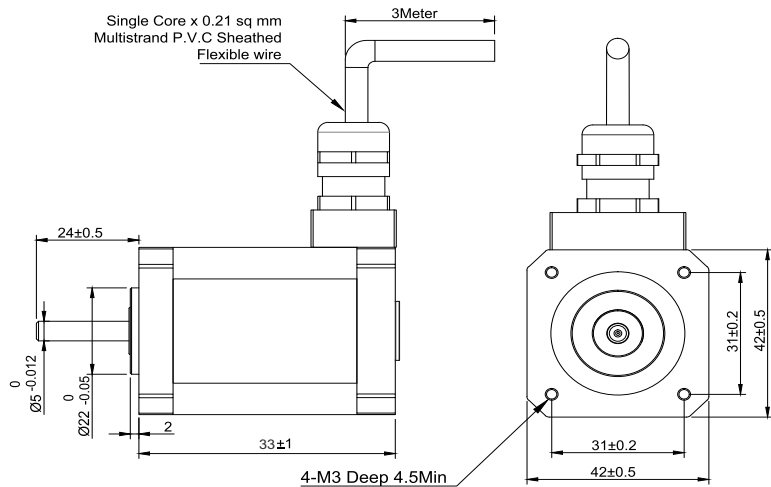
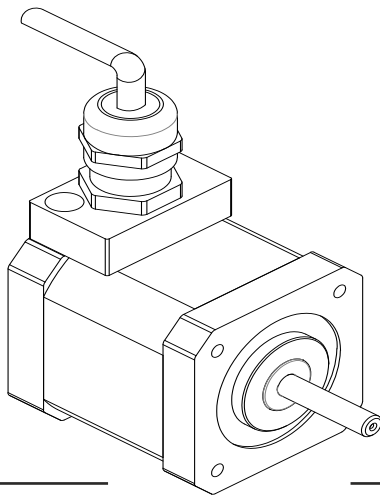

TECHNICAL DATA

CHARACTERISTICS

Step Angle - 1.8°
Step Angle Accuracy - ± 3 Arc Minute
Insulation Class - H
Ambient Temperature - - 20°C + 50°C
Temperature Rise - 80°C Max. (Rated Current Phase 2 ON)
Insulation Resistance 100 M Ohms Min.500 VDC
Dielectric Strength 500 VAC For One Minute
Shaft Radial Play 0.02 Max. Play (450 G Load)
Shaft Axial Play 0.08 Max. Play (450 G Load)
Max.Radial Force 28 N (20MM From Front Flange)
Max.Axial Force 10 N

SPECIFICATION BH42SH33-1334A-CE

MODEL	Bipolar	
1 Rated Voltage	V	2.8
2 Current / Phase	A	1.33
3 Resistance / Phase	± 10% Ω	2.1
4 Inductance / Phase	± 20% mH	1.6
5 Holding Torque	Nm	0.22
6 Rotor Inertia	G-CM ²	35
7 Weight	KG.	0.27
8 No of Lead	N ⁰	4
9 Operating Voltage	VDC	12 - 24

Wiring Diagram

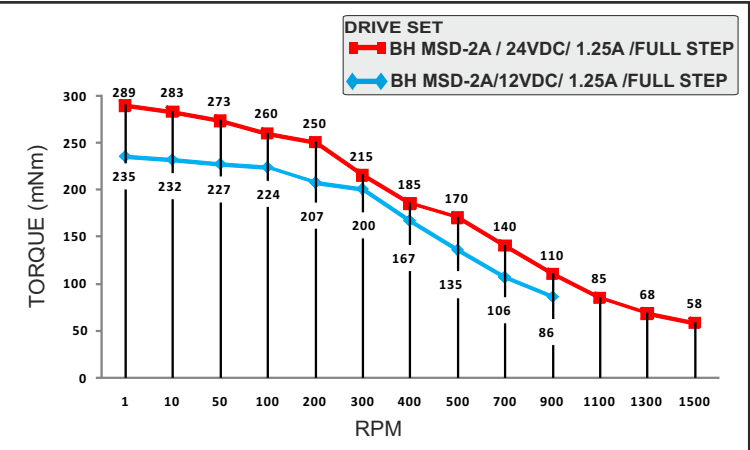
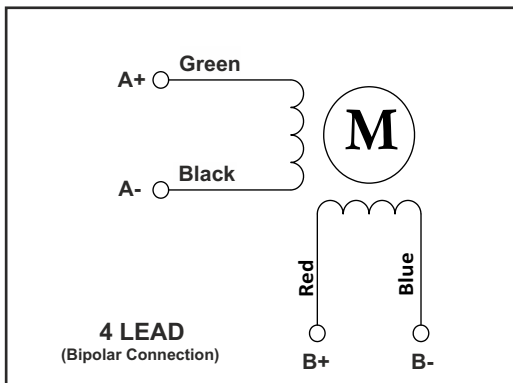

MOTOR MODEL - BH42SH33-1334A-CE



Bholanath Precision Engineering Pvt.Ltd.

11,Kembros Ind.Estate , Sonapur Lane , Bhandup (W),Mumbai - 400078.
Telefax/Phone : 25662856/25664338/67993260 Email : support@bholanath.in
Mobile No : 9920903825/9821671733/9930514603/9819515543/9323166582.